

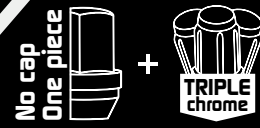

BOLTS AND NUTS

07-08	ACURA	46-48	GMC	81-82	MERCURY
09	ALFA ROMEO	49-51	HONDA	83	MINI COOPER
10	AUDI	52	HUMMER	84-85	MITSUBISHI
11	BENTLEY	53-54	HYUNDAI	86	NISSAN
12	BMW	55-56	INFINITY	87	OLDSMOBILE
13-15	BUICK	57-58	ISUZU	88	PLYMOUTH
16-18	CADILLAC	59-61	JAGUAR	89-90	PONTIAC
19-22	CHEVROLET	62-64	JEEP	91-92	SAAB
23-25	CHRYSLER	65-66	KIA	93	SMART
26	DAEWOO	67-68	LAND ROVER	94	SUBARU
27-32	DODGE	69-70	LEXUS	95-96	SUZUKI
33-36	DODGE RAM	71-74	LINCOLN	97	TESLA
37-38	FIAT	75	LOTUS	98-100	TOYOTA
39-43	FORD	76-78	MAZDA	101	VOLKSWAGEN
44-45	GENESIS	79-80	MERCEDES BENZ	102	VOLVO



EPICOR & **Ready Online!**

OEM Wheel Seat Application

OEM NUTS

1907HR

Description: Close end ball seat R12

Quantity: 40/box

Finish: Chrome

Thread: M12 x 1.5mm

Hex: 19mm

Overall length: 35mm

Seat diameter: 22mm



1909OR

Description: Close end ball seat R14

Quantity: 40/box

Finish: Chrome

Thread: M14 x 1.5mm

Hex: 22mm

Overall length: 36.2mm

Seat diameter: 26mm



075

Description: Close end ball seat R14

Quantity: 80/box

Finish: Chrome

Thread: M12 x 1.5mm

Hex: 19mm

Overall length: 23.6mm

Seat diameter: 21.9mm



OEM BOLTS

1809P I

Description: Variable ball seat R14

Quantity: 25/box

Finish: Black coat

Thread: M14 x 1.5mm

Hex: 19mm

Overall length: 58.3mm

Thread length: 19mm

Seat diameter: 24.8mm



OEM COVER RETAINING

1907WR

Description: Close end ball seat R12 with plastic washer

Quantity: 40/box

Finish: Chrome

Thread: M12 x 1.5mm

Hex: 19mm

Overall length: 32.8mm

Seat diameter: 22.8mm

Washer diameter: 28mm



1909WR

Description: Close end ball seat R14 with plastic washer

Quantity: 40/box

Finish: Chrome

Thread: M14 x 1.5mm

Hex: 22mm

Overall length: 36.2mm

Seat diameter: 26mm

Washer diameter: 28mm



OPEN END BALL SEAT

1307-IR

Description: Open end R12 ball seat

Quantity: 80/box

Finish: Chrome

Thread: M12 x 1.5mm

Hex: 19mm

Overall length: 21mm



1309-IR

Description: Open end R12 ball seat

Quantity: 80/box

Finish: Chrome

Thread: M14 x 1.5mm

Hex: 19mm

Overall length: 21mm



Aftermarket Wheel Seat Application

CLOSE END BULGE SEAT

1907S

Description: Close end bulge seat

Quantity: 50/box

Finish: Chrome

Thread: M12 x 1.5mm

Hex: 19mm

Overall length: 34.7mm

Seat diameter: 22mm



1707BK

Description: Close end bulge seat

Quantity: 50/box

Finish: Black Coat

Thread: M12 x 1.5mm

Hex: 19mm

Overall length: 34.5mm

Seat diameter: 22mm



1909 S

Description: Close end bulge seat

Quantity: 50/box

Finish: Chrome

Thread: M14 x 1.5mm

Hex: 19mm

Overall length: 35.6mm



OPEN END CONE SEAT

1307

Description: Open end 60° cone seat

Quantity: 100/box

Finish: Chrome

Thread: M12 x 1.5mm

Hex: 19mm

Overall length: 16.1mm



OPEN END BULGE SEAT

1307-IS

Description: Open end bulge seat

Quantity: 100/box

Finish: Chrome

Thread: M12 x 1.5mm

Hex: 19mm

Overall length: 21.4mm



1309-IS

Description: Open end bulge seat

Quantity: 100/box

Finish: Chrome

Thread: M14 x 1.5mm

Hex: 19mm

Overall length: 21.4mm



OPEN END BULGE SEAT 6 SPLINE

3807-IC

Description: Open end bulge seat

Quantity: 100

Finish: Chrome

Thread: M12 x 1.5mm

Hex: 19mm

Overall length: 21mm

Seat diameter: 20.2mm

Operating key: 3800/3800s



3809-IC

Description: Open end bulge seat

Quantity: 80/box

Finish: Chrome

Thread: M14 x 1.5mm

Hex: 19mm

Overall length: 24.5mm

Seat diameter: 23.1mm

Operating key: 3800LD



CLOSE END BULGE SEAT 6 SPLINE

3807-C

Description: Close end bulge seat

Quantity: 80/box

Finish: Chrome

Thread: M12 x 1.5mm

Hex: 19mm

Overall length: 33.2mm

Seat diameter: 20.2mm

Operating key: 3800/3800s



3807-BK

Description: Close end bulge seat

Quantity: 80/box

Finish: Black coat

Thread: M12 x 1.5mm

Hex: 19mm

Overall length: 33.2mm

Seat diameter: 21mm

Operating key: 3800/3800s



3809-C

Description: Close end bulge seat

Quantity: 80/box

Finish: Chrome

Thread: M14 x 1.5mm

Hex: 22mm

Overall length: 35.4mm

Seat diameter: 20.2mm

Operating key: 3800/3800s



3809-BK

Description: Close end bulge seat

Quantity: 80/box

Finish: Black Coat

Thread: M14 x 1.5mm

Hex: 22mm

Overall length: 35.4mm

Seat diameter: 20.2mm

Operating key: 3800/3800s



OPEN END BULGE SEAT 7 SPLINE

3809-IDC

Description: Open end bulge seat

Quantity: 80/box

Finish: Chrome

Thread: M14 x 1.5mm

Hex: 22mm

Overall length: 25.4mm

Seat diameter: 23.3mm

Operating key: 3800L



CLOSE END BULGE SEAT 7 SPLINE

3809-DC

Description: Close end bulge seat

Quantity: 80/box

Finish: Chrome

Thread: M14 x 1.5mm

Hex: 22mm

Overall length: 43.1mm

Seat diameter: 19.4mm

Operating key: 3800L



3809-DBK

Description: Close end bulge seat

Quantity: 80/box

Finish: Black Coat

Thread: M14 x 1.5mm

Hex: 22mm

Overall length: 43.1mm

Seat diameter: 19.4mm

Operating key: 3800L



TUNER NUT

2807

Description: Inverted hex tuner nut

Quantity: 50/box

Finish: Chrome

Thread: M12 x 1.5mm

Hex: 12mm

Overall length: 32.6mm

Seat diameter: 20mm

Operating key: 2800



2807 BK

Description: Inverted hex tuner nut

Quantity: 50/box

Finish: Black coat

Thread: M12 x 1.5mm

Hex: 12mm

Overall length: 32.6mm

Seat diameter: 20mm

Operating key: 2800



2807 L

Description: Inverted hex tuner nut

Quantity: 25/box

Finish: Chrome

Thread: M14 x 1.5mm

Hex: 15mm

Overall length: 45.4mm

Seat diameter: 20mm

Operating key: 2800L

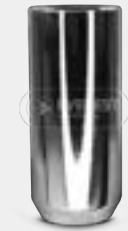

DUAL HEX TUNER KEY

2800

Description: Dual hex tuner key

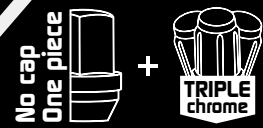

OEM BOLTS

<p>18205 Description: 60° Cone seat Quantity: 50/box Finish: Chrome Thread: M14 x 1.5mm Hex: 17mm Overall length: 50.5mm Thread length: 24mm Seat diameter: 22mm</p> 	<p>18205BK Description: 60° Cone seat Quantity: 50/box Finish: Black coat Thread: M14 x 1.5mm Hex: 17mm Overall length: 50.5mm Thread length: 24mm Seat diameter: 22mm</p> 	<p>1807A Description: 60° Cone seat Quantity: 50/box Finish: Chrome Thread: M12 x 1.25 mm Hex: 17mm Overall length: 55.8mm Thread length: 28mm Seat diameter: 22mm</p> 	<p>1807ABK Description: 60° Cone seat Quantity: 50/box Finish: Black coat Thread: M12 x 1.25 mm Hex: 17mm Overall length: 55.8mm Thread length: 28mm Seat diameter: 22mm</p> 
---	---	--	---

OEM SIZE SPLINE BOLT 6 SPLINE

<p>18205SPC Description: 60° Cone seat Quantity: 50/box Finish: Chrome Thread: M14 x 1.5mm Hex: 6 Spline Overall length: 54.5mm Thread length: 24mm Seat diameter: 20.2mm Operating key: 3800/3800s</p> 	<p>18205SPBK Description: 60° Cone seat Quantity: 50/box Finish: Black coat Thread: M14 x 1.5mm Hex: 6 Spline Overall length: 54.5mm Thread length: 24mm Seat diameter: 20.2mm Operating key: 3800/3800s</p> 
---	--

DUAL HEX 6 SPLINE KEY

<p>3800S Description: 6 splines Quantity: 30/box Finish: Chrome Hex: 17mm/19mm Overall length: 73.1mm Seat diameter: 20.4mm</p> 	<p>3800 Description: 6 splines Quantity: 20/box Finish: Chrome/Black Hex: 19mm/21mm Overall length: 90mm Seat diameter: 20.4mm</p> 
--	---

OEM Wheel Seat Application

OEM BOLT

<p>18095 I Description: R13 Ball seat Quantity: 50/box Finish: Chrome Thread: M14 x 1.5mm Hex: 17m Overall length: 50mm Thread length: 25mm Seat diameter: 23mm</p> 	<p>18095 I BK Description: R13 Ball seat Quantity: 50/box Finish: Black coat Thread: M14 x 1.5mm Hex: 17m Overall length: 50mm Thread length: 25mm Seat diameter: 23mm</p> 	<p>1809Q Description: Variable ball seat R14 Quantity: 25/box Finish: Dacromet Thread: M14 x 1.5mm Hex: 17m Overall length: 61mm Thread length: 22mm Seat diameter: 23.5mm</p> 
--	---	---

OEM SPLINED BOLT 6 SPLINE

<p>18095 I PC Description: R13 Ball seat Quantity: 50/box Finish: Chrome Thread: M14 x 1.5mm Hex: 6 spline Overall length: 50mm Thread length: 25mm Seat diameter: 23mm Operating key: 3800/3800s</p> 
--

Aftermarket Wheel Seat Application

OEM SIZE BOLTS

<p>18205 Description: 60° Cone seat Quantity: 50/box Finish: Chrome Thread: M14 x 1.5mm Hex: 17mm Overall length: 50.5mm Thread length: 24mm Seat diameter: 22mm</p> 	<p>18205BK Description: 60° Cone seat Quantity: 50/box Finish: Black Coat Thread: M14 x 1.5mm Hex: 17mm Overall length: 50.5mm Thread length: 24mm Seat diameter: 22mm</p> 
--	--

<p>18095 I PBK Description: R13 Ball seat Quantity: 50/box Finish: Black coat Thread: M14 x 1.5mm Hex: 6 spline Overall length: 50mm Thread length: 25mm Seat diameter: 23mm Operating key: 3800/3800s</p> 
--

OEM SIZE SPLINE BOLTS 6 SPLINE

<p>18205SPC Description: 60° Cone seat Quantity: 50/box Finish: Chrome Thread: M14 x 1.5mm Hex: 6 Spline Overall length: 54.5mm Thread length: 24mm Seat diameter: 20.2mm Operating key: 3800/3800s</p> 	<p>18205SPBK Description: 60° Cone seat Quantity: 50/box Finish: Black coat Thread: M14 x 1.5mm Hex: 6 Spline Overall length: 54.5mm Thread length: 24mm Seat diameter: 20.2mm Operating key: 3800/3800s</p> 
--	---

DUAL HEX 6 SPLINE KEY

<p>3800S Description: 6 splines Quantity: 30/box Finish: Chrome Hex: 17mm/19mm Overall length: 73.1mm Seat diameter: 20.4mm</p> 	<p>3800 Description: 6 splines Quantity: 20/box Finish: Chrome/Black Hex: 19mm/21mm Overall length: 90mm Seat diameter: 20.4mm</p> 
--	---

AUDI

AUDI

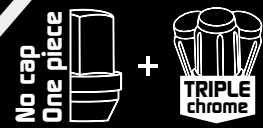

OEM Wheel Seat Application

OEM BOLT

18095 I

Description:
R13 Ball seat



Quantity: 50/box
Finish: Chrome
Thread: M14 x 1.5mm
Hex: 17mm
Overall length: 50mm
Thread length: 25mm
Seat diameter: 23mm

18095 I BK

Description:
R13 Ball seat



Quantity: 50/box
Finish: Black coat
Thread: M14 x 1.5mm
Hex: 17mm
Overall length: 50mm
Thread length: 25mm
Seat diameter: 23mm

OEM SPLINED BOLT

6 SPLINE

18095 I PC

Description:
R13 Ball seat



Quantity: 50/box
Finish: Chrome
Thread: M14 x 1.5mm
Hex: 6 spline
Overall length: 50mm
Thread length: 25mm
Seat diameter: 23mm
Operating key: 3800/3800s

18095 I PBK

Description:
R13 Ball seat



Quantity: 50/box
Finish: Black coat
Thread: M14 x 1.5mm
Hex: 6 spline
Overall length: 50mm
Thread length: 25mm
Seat diameter: 23mm
Operating key: 3800/3800s

Aftermarket Wheel Seat Application

OEM SIZE BOLTS

18205

Description:
60° Cone seat



Quantity: 50/box
Finish: Chrome
Thread: M14 x 1.5mm
Hex: 17mm
Overall length: 50.5mm
Thread length: 24mm
Seat diameter: 22mm

18205BK

Description:
60° Cone seat



Quantity: 50/box
Finish: Black coat
Thread: M14 x 1.5mm
Hex: 17mm
Overall length: 50.5mm
Thread length: 24mm
Seat diameter: 22mm

OEM SIZE SPLINEBOLTS

6 SPLINE

18205SPC

Description:
60° Cone seat



Quantity: 50/box
Finish: Chrome
Thread: M14 x 1.5mm
Hex: 6 Spline
Overall length: 54.5mm
Thread length: 24mm
Seat diameter: 20.2mm
Operating key: 3800/3800s

18205SPBK

Description:
60° Cone seat



Quantity: 50/box
Finish: Black coat
Thread: M14 x 1.5mm
Hex: 6 Spline
Overall length: 54.5mm
Thread length: 24mm
Seat diameter: 20.2mm
Operating key: 3800/3800s

DUAL HEX 6 SPLINE KEY

3800S

Description:
6 splines



Quantity: 30/box
Finish: Chrome
Hex: 17mm/19mm
Overall length: 73.1mm
Seat diameter: 20.4mm

3800

Description:
6 splines



Quantity: 20/box
Finish: Chrome/Black
Hex: 19mm/21mm
Overall length: 90mm
Seat diameter: 20.4mm

OEM BOLTS

182 I-I

Description:
60° Cone seat

Quantity:
50/box

Finish:
Chrome

Thread: M14 x 1.25mm
Hex: 17mm

Overall length: 48mm
Thread length: 22mm
Seat diameter: 22mm



182 I-BK

Description:
60° Cone seat

Quantity:
50/box

Finish:
Black coat

Thread: M14 x 1.25mm
Hex: 17mm

Overall length: 48mm
Thread length: 22mm
Seat diameter: 22mm



182 I X7

Description:
60° Cone seat

Quantity:
50/box

Finish:
Black coat

Thread: M14 x 1.25 mm
Hex: 17mm

Overall length: 54.3mm
Thread length: 22mm
Seat diameter: 25mm



1806

Description:
60° Cone seat

Quantity:
50/box

Finish:
Chrome

Thread: M12 x 1.5mm
Hex: 17mm

Overall length: 52.2mm
Thread length: 24mm
Seat diameter: 22.7mm



1806BK

Description:
60° Cone seat

Quantity:
50/box

Finish:
Black coat

Thread: M12 x 1.5mm
Hex: 17mm

Overall length: 52.2mm
Thread length: 24mm
Seat diameter: 22.7mm



1822

Description:
60° Cone seat

Quantity:
50/box

Finish:
Chrome

Thread: M14 x 1.5mm
Hex: 17mm

Overall length: 54.6mm
Thread length: 28mm
Seat diameter: 22mm



1822BK

Description:
60° Cone seat

Quantity:
50/box

Finish:
Black coat

Thread: M14 x 1.5mm
Hex: 17mm

Overall length: 54.6mm
Thread length: 28mm
Seat diameter: 22mm



OEM SPLINE BOLTS

6 SPLINE

18025PC

Description:
60° Cone seat

Quantity:
50/box

Finish:
Chrome

Thread: M14 x 1.25mm
Hex: 6 SPLINE

Overall length: 51.3mm
Thread length: 24mm
Seat diameter: 20.5mm
Operating key: 3800/3800S



18025PBK

Description:
60° Cone seat

Quantity:
50/box

Finish:
Black coat

Thread: M14 x 1.25mm
Hex: 6 SPLINE

Overall length: 51.3mm
Thread length: 24mm
Seat diameter: 20.5mm
Operating key: 3800/3800S



1806SPC

Description:
60° Cone seat

Quantity:
50/box

Finish:
Chrome

Thread: M12 x 1.5 mm
Hex: 6 SPLINE

Overall length: 48.4mm
Thread length: 24mm
Seat diameter: 21mm
Operating key: 3800/3800S



1806SPBK

Description:
60° Cone seat

Quantity:
50/box

Finish:
Black coat

Thread: M12 x 1.5 mm
Hex: 6 SPLINE

Overall length: 48.4mm
Thread length: 24mm
Seat diameter: 21mm
Operating key: 3800/3800S



1820SPC

Description:
60° Cone seat

Quantity:
50/box

Finish:
Chrome

Thread: M14 x 1.5mm
Hex: 6 SPLINE

Overall length: 52mm
Thread length: 28mm
Seat diameter: 21.7mm
Operating key: 3800/3800s



1820SPBK

Description:
60° Cone seat

Quantity:
50/box

Finish:
Black coat

Thread: M14 x 1.5mm
Hex: 6 SPLINE

Overall length: 52mm
Thread length: 28mm
Seat diameter: 21.7mm
Operating key: 3800/3800s



3800S

Description:
6 splines

Quantity:
30/box

Finish:
Chrome

Hex: 17mm/19mm

Overall length: 73.1mm
Seat diameter: 20.4mm



3800

Description:
6 splines

Quantity:
20/box

Finish:
Chrome/Black

Hex: 19mm/21mm

Overall length: 90mm
Seat diameter: 20.4mm



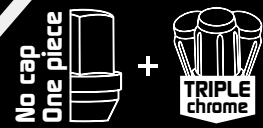

OEM NUTS

5308

Description: Close end bulge seat
Quantity: 30/box
Finish: Chrome
Thread: M14 x 1.5mm
Hex: 22mm
Overall length: 47.6mm
Seat diameter: 26.5mm



5308BK

Description: Close end bulge seat
Quantity: 30/box
Finish: Black coat
Thread: M14 x 1.5mm
Hex: 22mm
Overall length: 47.6mm
Seat diameter: 26.5mm



263

Description: Close end bulge seat
Quantity: 35/box
Finish: Chrome
Thread: M12 x 1.5mm
Hex: 19mm
Overall length: 34.8mm
Seat diameter: 21.3mm



5330

Description: Close end bulge seat
Quantity: 30/box
Finish: Chrome
Thread: M14 x 1.5mm
Hex: 22mm
Overall length: 38.3mm
Seat diameter: 25mm

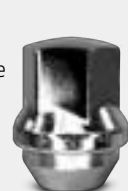

5330BK

Description: Close end bulge seat
Quantity: 30/box
Finish: Black coat
Thread: M14 x 1.5mm
Hex: 22mm
Overall length: 38.3mm
Seat diameter: 25mm



OEM COVER RETAINING NUT

2007S

Description: Open end Cap retaining thread
Quantity: 50/box
Finish: Zink plated
Thread: M12 x 1.5mm
Hex: 19mm
Overall length: 27mm
Seat diameter: 22.6mm
Cap retaining thread: M24 x 2.0mm



2006S

Description: Open end Cap retaining thread
Quantity: 50/box
Finish: Zink plated
Thread: M12 x 1.5mm
Hex: 19mm
Overall length: 31.8mm
Seat diameter: 22.6mm
Cap retaining thread: M24 x 2.0mm



OPEN END BULGE SEAT

1312

Description: Open end bulge seat
Quantity: 70/box
Finish: Chrome
Thread: M14 x 1.5mm
Hex: 22mm
Overall length: 21.4mm



1307-1S

Description: Open end bulge seat
Quantity: 100/box
Finish: Chrome
Thread: M12 x 1.5mm
Hex: 19mm
Overall length: 21.4mm



OPEN END CONE SEAT

1307

Description: Open end 60° cone seat
Quantity: 100/box
Finish: Chrome
Thread: M12 x 1.5mm
Hex: 19mm
Overall length: 16.1mm



CLOSE END CONE SEAT

1007

Description: Close end 60° cone seat
Quantity: 50/box
Finish: Chrome
Thread: M12 x 1.5mm
Hex: 21mm
Overall length: 35.3mm



CLOSE END BULGE SEAT

1907S

Description: Close end bulge seat
Quantity: 50/box
Finish: Chrome
Thread: M12 x 1.5mm
Hex: 19mm
Overall length: 34.7mm
Seat diameter: 22mm



1707BK

Description: Close end bulge seat
Quantity: 50/box
Finish: Black Coat
Thread: M12 x 1.5mm
Hex: 19mm
Overall length: 34.5mm
Seat diameter: 22mm



1909L

Description: Close end bulge seat
Quantity: 40/box
Finish: Chrome
Thread: M14 x 1.5mm
Hex: 21mm
Overall length: 45mm
Seat diameter: 24mm



DUPLEX ACORN

5401

Description: Close end Duplex Acorn
Quantity: 30/box
Finish: Chrome
Thread: M14 x 1.5mm
Hex: 22mm
Overall length: 48.2mm
Seat diameter: 25.5mm



5401BK

Description: Close end Duplex Acorn
Quantity: 30/box
Finish: Black coat
Thread: M14 x 1.5mm
Hex: 22mm
Overall length: 48.2mm
Seat diameter: 25.5mm



SHORT SHANK DUPLEX ACORN

3009

Description: Close end Duplex Acorn
Quantity: 30/box
Finish: Chrome
Thread: M14 x 1.5mm
Hex: 22mm
Overall length: 46.6mm
Seat diameter: 21.5mm



OPEN END BULGE SEAT 6 SPLINE

3807-1C

Description: Open end bulge seat
Quantity: 100
Finish: Chrome
Thread: M12 x 1.5mm
Hex: 19mm
Overall length: 21mm
Seat diameter: 20.2mm
Operating key: 3800/3800s



CLOSE END BULGE SEAT 6 SPLINE

3807-C

Description: Close end bulge seat
Quantity: 80/box
Finish: Chrome
Thread: M12 x 1.5mm
Hex: 19mm
Overall length: 33.2mm
Seat diameter: 20.2mm
Operating key: 3800/3800s



3807-BK

Description: Close end bulge seat
Quantity: 80/box
Finish: Black coat
Thread: M12 x 1.5mm
Hex: 19mm
Overall length: 33.2mm
Seat diameter: 21mm
Operating key: 3800/3800s



OPEN END BULGE SEAT 7 SPLINE

3809-1DC

Description: Open end bulge seat
Quantity: 80/box
Finish: Chrome
Thread: M14 x 1.5mm
Hex: 22mm
Overall length: 25.4mm
Seat diameter: 23.3mm
Operating key: 3800L



CLOSE END BULGE SEAT 7 SPLINE

3809-DC

Description: Close end bulge seat
Quantity: 40/box
Finish: Chrome
Thread: M14 x 1.5mm
Hex: 22mm
Overall length: 43.1mm
Seat diameter: 19.4mm
Operating key: 3800L



3809-DBK

Description: Close end bulge seat
Quantity: 40/box
Finish: Black Coat
Thread: M14 x 1.5mm
Hex: 22mm
Overall length: 43.1mm
Seat diameter: 19.4mm
Operating key: 3800L



3809-DLC

Description: Close end bulge seat
Quantity: 40/box
Finish: Chrome
Thread: M14 x 1.5mm
Hex: 22mm
Overall length: 51.7mm
Seat diameter: 23mm
Operating key: 3800L



3809-DLBK

Description: Close end bulge seat
Quantity: 40/box
Finish: Black Coat
Thread: M14 x 1.5mm
Hex: 22mm
Overall length: 51.7mm
Seat diameter: 23mm
Operating key: 3800L



3

Times Chromed
Times The Satisfaction



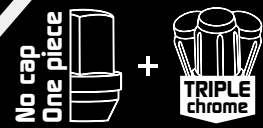

EPICOR & Ready Online!

TUNER NUT

2807

Description: Inverted hex tuner nut
Quantity: 50/box
Finish: Chrome
Thread: M12 x 1.5mm
Hex: 12mm
Overall length: 32.6mm
Seat diameter: 20mm
Operating key: 2800



2807 BK

Description: Inverted hex tuner nut
Quantity: 50/box
Finish: Black coat
Thread: M12 x 1.5mm
Hex: 12mm
Overall length: 32.6mm
Seat diameter: 20mm
Operating key: 2800



2807 L

Description: Inverted hex tuner nut
Quantity: 25/box
Finish: Chrome
Thread: M14 x 1.5mm
Hex: 15mm
Overall length: 45.4mm
Seat diameter: 20mm
Operating key: 2800L



DUAL HEX SPLINE KEY

3800S

Description: 6 splines
Quantity: 30/box
Finish: Chrome
Hex: 17mm/19mm
Overall length: 73.1mm
Seat diameter: 20.4mm



3800

Description: 6 splines
Quantity: 20/box
Finish: Chrome/Black
Hex: 19mm/21mm
Overall length: 90mm
Seat diameter: 20.4mm



3800L

Description: 7 splines
Quantity: 20/box
Finish: Chrome/Black
Hex: 21mm/22mm
Overall length: 82mm
Seat diameter: 23mm



DUAL HEX TUNER KEY

2800

Description: Inverted hex tuner key
Quantity: 30/box
Finish: Chrome
Hex: 19mm/21mm
Key Hex: 12mm
Overall length: 57.9mm



2800L

Description: Inverted hex tuner key
Quantity: 30/box
Finish: Chrome
Hex: 19mm/21mm
Key Hex: 14.7mm
Overall length: 63.5mm



DEM NUTS

5308

Description: Close end bulge seat
Quantity: 30/box
Finish: Chrome
Thread: M14 x 1.5mm
Hex: 22mm
Overall length: 47.6mm
Seat diameter: 26.5mm



5308BK

Description: Close end bulge seat
Quantity: 30/box
Finish: Black coat
Thread: M14 x 1.5mm
Hex: 22mm
Overall length: 47.6mm
Seat diameter: 26.5mm



263

Description: Close end bulge seat
Quantity: 35/box
Finish: Chrome
Thread: M12 x 1.5mm
Hex: 19mm
Overall length: 34.8mm
Seat diameter: 21.3mm

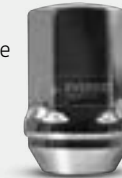

5330

Description: Close end bulge seat
Quantity: 30/box
Finish: Chrome
Thread: M14 x 1.5mm
Hex: 22mm
Overall length: 38.3mm
Seat diameter: 25mm



COVER RETAINING NUT

5330BK

Description: Close end bulge seat
Quantity: 30/box
Finish: Black coat
Thread: M14 x 1.5mm
Hex: 22mm
Overall length: 38.3mm
Seat diameter: 25mm



2006S

Description: Open end Cap retaining thread
Quantity: 50/box
Finish: Zink plated
Thread: M12 x 1.5mm
Hex: 19mm
Overall length: 31.8mm
Seat diameter: 22.6mm
Cap retaining thread: M24 x 2.0mm



DEM BOLT

1806SA

Description: 60° Cone seat
Quantity: 50/box
Finish: Chrome
Thread: M12 x 1.5mm
Hex: 17mm
Overall length: 50mm
Thread length: 22mm
Seat diameter: 22mm



OPEN END CONE SEAT

1307

Description: Open end 60° cone seat
Quantity: 100/box
Finish: Chrome
Thread: M12 x 1.5mm
Hex: 19mm
Overall length: 16.1mm



OPEN END BULGE SEAT

1312

Description: Open end bulge seat
Quantity: 70/box
Finish: Chrome
Thread: M14 x 1.5mm
Hex: 22mm
Overall length: 21.4mm



1307-15

Description: Open end bulge seat
Quantity: 100/box
Finish: Chrome
Thread: M12 x 1.5mm
Hex: 19mm
Overall length: 21.4mm



CLOSE END CONE SEAT

1007

Description: Close end 60° cone seat
Quantity: 50/box
Finish: Chrome
Thread: M12 x 1.5mm
Hex: 21mm
Overall length: 35.3mm



CLOSE END BULGE SEAT

1907S

Description: Close end bulge seat
Quantity: 50/box
Finish: Chrome
Thread: M12 x 1.5mm
Hex: 19mm
Overall length: 34.7mm
Seat diameter: 22mm



1707BK

Description: Close end bulge seat
Quantity: 50/box
Finish: Black Coat
Thread: M12 x 1.5mm
Hex: 19mm
Overall length: 34.5mm
Seat diameter: 22mm



1909L

Description: Close end bulge seat
Quantity: 40/box
Finish: Chrome
Thread: M14 x 1.5mm
Hex: 21mm
Overall length: 45mm
Seat diameter: 24mm

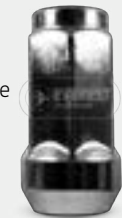

CADILLAC

CADILLAC



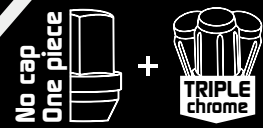

DUPLEX ACORN

540 I

Description: Close end Duplex Acorn

Quantity: 30/box

Finish: Chrome

Thread: M14 x 1.5mm

Hex: 22mm

Overall length: 48.2mm

Seat diameter: 25.5mm



540 I BK

Description: Close end Duplex Acorn

Quantity: 30/box

Finish: Black coat

Thread: M14 x 1.5mm

Hex: 22mm

Overall length: 48.2mm

Seat diameter: 25.5mm



SHORT SHANK DUPLEX ACORN

3009

Description: Close end Duplex Acorn

Quantity: 30/box

Finish: Chrome

Thread: M14 x 1.5mm

Hex: 22mm

Overall length: 46.6mm

Seat diameter: 21.5mm



OPEN END BULGE SEAT 6 SPLINE

3807-IC

Description: Open end bulge seat

Quantity: 100

Finish: Chrome

Thread: M12 x 1.5mm

Hex: 6 SPLINE

Overall length: 21mm

Seat diameter: 20.2mm

Operating key: 3800/3800s



CLOSE END BULGE SEAT 6 SPLINE

3807-C

Description: Close end bulge seat

Quantity: 80/box

Finish: Chrome

Thread: M12 x 1.5mm

Hex: 6 SPLINE

Overall length: 33.2mm

Seat diameter: 20.2mm

Operating key: 3800/3800s



3807-BK

Description: Close end bulge seat

Quantity: 80/box

Finish: Black coat

Thread: M12 x 1.5mm

Hex: 6 SPLINE

Overall length: 33.2mm

Seat diameter: 21mm

Operating key: 3800/3800s



OPEN END BULGE SEAT 7 SPLINE

3809-IDC

Description: Open end bulge seat

Quantity: 80/box

Finish: Chrome

Thread: M14 x 1.5mm

Hex: 7 SPLINE

Overall length: 25.4mm

Seat diameter: 23.3mm

Operating key: 3800L



CLOSE END BULGE SEAT 7 SPLINE

3809-DC

Description: Close end bulge seat

Quantity: 40/box

Finish: Chrome

Thread: M14 x 1.5mm

Hex: 7 SPLINE

Overall length: 43.1mm

Seat diameter: 19.4mm

Operating key: 3800L



3809-DBK

Description: Close end bulge seat

Quantity: 40/box

Finish: Black Coat

Thread: M14 x 1.5mm

Hex: 7 SPLINE

Overall length: 43.1mm

Seat diameter: 19.4mm

Operating key: 3800L



3809-DLC

Description: Close end bulge seat

Quantity: 40/box

Finish: Chrome

Thread: M14 x 1.5mm

Hex: 7 SPLINE

Overall length: 51.7mm

Seat diameter: 23mm

Operating key: 3800L



3809-DLBK

Description: Close end bulge seat

Quantity: 40/box

Finish: Black Coat

Thread: M14 x 1.5mm

Hex: 7 SPLINE

Overall length: 51.7mm

Seat diameter: 23mm

Operating key: 3800L



All Nuts

TUNER NUT

2807

Description: Inverted hex tuner nut

Quantity: 50/box

Finish: Chrome

Thread: M12 x 1.5mm

Hex: 12mm

Overall length: 32.6mm

Seat diameter: 20mm

Operating key: 2800



2807 BK

Description: Inverted hex tuner nut

Quantity: 50/box

Finish: Black coat

Thread: M12 x 1.5mm

Hex: 12mm

Overall length: 32.6mm

Seat diameter: 20mm

Operating key: 2800



2807 L

Description: Inverted hex tuner nut

Quantity: 25/box

Finish: Chrome

Thread: M14 x 1.5mm

Hex: 15mm

Overall length: 45.4mm

Seat diameter: 20mm

Operating key: 2800L



OEM SIZE SPLINE BOLT 6 SPLINE

180 I SPC

Description: 60° Cone seat



Quantity: 50/box

Finish: Chrome

Hex: M12 x 1.5mm

Thread: 6 SPLINE

Overall length: 49mm

Thread length: 22mm

Seat diameter: 20.5mm

Operating key: 3800S

180 I SPBK

Description: 60° Cone seat



Quantity: 50/box

Finish: Black coat

Hex: M12 x 1.5mm

Thread: 6 SPLINE

Overall length: 49mm

Thread length: 22mm

Seat diameter: 20.5mm

Operating key: 3800S

DUAL HEX SPLINE KEY

3800S

Description: 6 splines



Quantity: 30/box

Finish: Chrome

Hex: 17mm/19mm

Overall length: 73.1mm

Seat diameter: 20.4mm

3800

Description: 6 splines



Quantity: 20/box

Finish: Chrome/Black

Hex: 19mm/21mm

Overall length: 90mm

Seat diameter: 20.4mm

3800LD

Description: 6 splines



Quantity: 20/box

Finish: Chrome/Black

Hex: 21mm/22mm

Overall length: 82mm

Seat diameter: 23.3mm

3800L

Description: 7 splines



Quantity: 20/box

Finish: Chrome/Black

Hex: 21mm/22mm

Overall length: 82mm

Seat diameter: 23mm

DUAL HEX TUNER KEY

2800



Quantity: 30/box

Finish: Chrome

Hex: 19mm/21mm

Key Hex: 12mm

Overall length: 57.9mm

2800L



Quantity: 30/box

Finish: Chrome

Hex: 19mm/21mm

Key Hex: 14.7mm

Overall length: 63.5mm

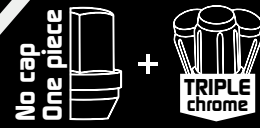

EPICOR & WHI
Ready Online!

DEM NUTS

5308

Description: Close end bulge seat

Quantity: 30/box

Finish: Chrome

Thread: M14 x 1.5mm

Hex: 22mm

Overall length: 47.6mm

Seat diameter: 26.5mm



5308BK

Description: Close end bulge seat

Quantity: 30/box

Finish: Black coat

Thread: M14 x 1.5mm

Hex: 22mm

Overall length: 47.6mm

Seat diameter: 26.5mm



263

Description: Close end bulge seat

Quantity: 35/box

Finish: Chrome

Thread: M12 x 1.5mm

Hex: 19mm

Overall length: 34.8mm

Seat diameter: 21.3mm



5330

Description: Close end bulge seat

Quantity: 30/box

Finish: Chrome

Thread: M14 x 1.5mm

Hex: 22mm

Overall length: 38.3mm

Seat diameter: 25mm



5330BK

Description: Close end bulge seat

Quantity: 30/box

Finish: Black coat

Thread: M14 x 1.5mm

Hex: 22mm

Overall length: 38.3mm

Seat diameter: 25mm



DEM FLAT FLANGE

202

Description: Cap retaining variable flat faced flange

Quantity: 20/box

Finish: Black coat

Thread: M14 x 1.5mm

Hex: 22mm

Overall length: 33mm

Flange diameter: 45mm

Flange thickness: 10mm

Washer diameter: M27 x 2.0mm



DEM COVER RETAINING NUT

2007S

Description: Open end Cap retaining thread

Quantity: 50/box

Finish: Zink plated

Thread: M12 x 1.5mm

Hex: 19mm

Overall length: 27mm

Seat diameter: 22.6mm

Cap retaining thread: M24 x 2.0mm



2006S

Description: Open end Cap retaining thread

Quantity: 50/box

Finish: Zink plated

Thread: M12 x 1.5mm

Hex: 19mm

Overall length: 31.8mm

Seat diameter: 22.6mm

Cap retaining thread: M24 x 2.0mm



2009

Description: Open end Cap retaining thread

Quantity: 40/box

Finish: Zink plated

Thread: M14 x 1.5mm

Hex: 22mm

Overall length: 29mm

Seat diameter: 25mm

Cap retaining thread: M27 x 2.0mm



OPEN END BULGE SEAT

I307-1S

Description: Open end bulge seat

Quantity: 100/box

Finish: Chrome

Thread: M12 x 1.5mm

Hex: 19mm

Overall length: 21.4mm



I312

Description: Open end bulge seat

Quantity: 70/box

Finish: Chrome

Thread: M14 x 1.5mm

Hex: 22mm

Overall length: 21.4mm



I304-1S

Description: Open end bulge seat

Quantity: 100/box

Finish: Chrome

Thread: 1/2"

Hex: 19mm

Overall length: 21.4mm



I306-1S

Description: Open end bulge seat

Quantity: 100/box

Finish: Chrome

Thread: M12 x 1.25mm

Hex: 19mm

Overall length: 21.4mm



OPEN END CONE SEAT

I307

Description: Open end 60° cone seat

Quantity: 100/box

Finish: Chrome

Thread: M12 x 1.5mm

Hex: 19mm

Overall length: 16.1mm

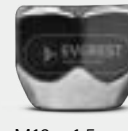

I304

Description: Open end 60° cone seat

Quantity: 100/box

Finish: Chrome

Thread: 1/2"

Hex: 19mm

Overall length: 16.1mm



I306

Description: Open end 60° cone seat

Quantity: 100/box

Finish: Chrome

Thread: M12 x 1.25mm

Hex: 19mm

Overall length: 16.1mm



OPEN END CONE SEAT

I327

Description: Open end 60° cone seat

Quantity: 100/box

Finish: Chrome

Thread: M12 x 1.5mm

Hex: 21mm

Overall length: 16mm



CLOSE END CONE SEAT

I006

Description: Close end 60° cone seat

Quantity: 50/box

Finish: Chrome

Thread: M12 x 1.25mm

Hex: 21mm

Overall length: 35.3mm



I007

Description: Close end 60° cone seat

Quantity: 50/box

Finish: Chrome

Thread: M12 x 1.5mm

Hex: 21mm

Overall length: 35.3mm



3 Times Chromed

Times The Satisfaction



CLOSE END BULGE SEAT

I907S

Description: Close end bulge seat

Quantity: 50/box

Finish: Chrome

Thread: M12 x 1.5mm

Hex: 19mm

Overall length: 34.7mm

Seat diameter: 22mm



I707BK

Description: Close end bulge seat

Quantity: 50/box

Finish: Black Coat

Thread: M12 x 1.5mm

Hex: 19mm

Overall length: 34.5mm

Seat diameter: 22mm



I907SL

Description: Close end bulge seat

Quantity: 40/box

Finish: Chrome

Thread: M12 x 1.5mm

Hex: 19mm

Overall length: 50mm

Seat diameter: 23mm



I909L

Description: Close end bulge seat

Quantity: 40/box

Finish: Chrome

Thread: M14 x 1.5mm

Hex: 21mm

Overall length: 45mm

Seat diameter: 24mm



I904S

Description: Close end bulge seat

Quantity: 50/box

Finish: Chrome

Thread: 1/2"

Hex: 19mm

Overall length: 35.6mm

Seat diameter: 22mm



I904SBK

Description: Close end bulge seat

Quantity: 50/box

Finish: Black Coat

Thread: 1/2"

Hex: 19mm

Overall length: 35.6mm

Seat diameter: 22mm



I906S

Description: Close end bulge seat

Quantity: 50/box

Finish: Chrome

Thread: M12 x 1.25mm

Hex: 19mm

Overall length: 35.6mm

Seat diameter: 22mm



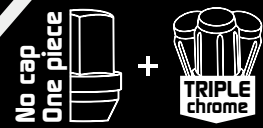

DUPLEX ACORN

540 I
Description: Close end Duplex Acorn
Quantity: 30/box
Finish: Chrome
Thread: M14 x 1.5mm
Hex: 22mm
Overall length: 48.2mm
Seat diameter: 25.5mm



540 I BK
Description: Close end Duplex Acorn
Quantity: 30/box
Finish: Black coat
Thread: M14 x 1.5mm
Hex: 22mm
Overall length: 48.2mm
Seat diameter: 25.5mm



SHORT SHANK DUPLEX ACORN

3009
Description: Close end Duplex Acorn
Quantity: 30/box
Finish: Chrome
Thread: M14 x 1.5mm
Hex: 22mm
Overall length: 46.6mm
Seat diameter: 21.5mm



OPEN END BULGE SEAT 6 SPLINE

3807-IC
Description: Open end bulge seat
Quantity: 100
Finish: Chrome
Thread: M12 x 1.5mm
Hex: 6 SPLINE
Overall length: 21mm
Seat diameter: 20.2mm
Operating key: 3800/3800s



3804-IC
Description: Open end bulge seat
Quantity: 100
Finish: Chrome
Thread: 1/2" 6 SPLINE
Hex: 21mm
Overall length: 21mm
Seat diameter: 20.2mm
Operating key: 3800/3800s



3806-IC
Description: Open end bulge seat
Quantity: 100
Finish: Chrome
Thread: M12 x 1.25mm
Hex: 6 SPLINE
Overall length: 21mm
Seat diameter: 20.2mm
Operating key: 3800/3800s



CLOSE END BULGE SEAT 6 SPLINE

3807-C
Description: Close end bulge seat
Quantity: 80/box
Finish: Chrome
Thread: M12 x 1.5mm
Hex: 6 SPLINE
Overall length: 33.2mm
Seat diameter: 20.2mm
Operating key: 3800/3800s



3807-BK
Description: Close end bulge seat
Quantity: 80/box
Finish: Black coat
Thread: M12 x 1.5mm
Hex: 6 SPLINE
Overall length: 33.2mm
Seat diameter: 21mm
Operating key: 3800/3800s



3804-C
Description: Close end bulge seat
Quantity: 80/box
Finish: Chrome
Thread: 1/2" 6 SPLINE
Hex: 33.2mm
Overall length: 20.2mm
Seat diameter: 21mm
Operating key: 3800/3800s



3804-BK
Description: Close end bulge seat
Quantity: 80/box
Finish: Black coat
Thread: 1/2" 6 SPLINE
Hex: 33.2mm
Overall length: 21mm
Seat diameter: 21mm
Operating key: 3800/3800s



3806-C
Description: Close end bulge seat
Quantity: 80/box
Finish: Chrome
Thread: M12 x 1.25mm
Hex: 6 SPLINE
Overall length: 33.2mm
Seat diameter: 20.2mm
Operating key: 3800/3800s



3806-BK
Description: Close end bulge seat
Quantity: 80/box
Finish: Black coat
Thread: M12 x 1.25mm
Hex: 6 SPLINE
Overall length: 33.2mm
Seat diameter: 21mm
Operating key: 3800/3800s



OPEN END BULGE SEAT 7 SPLINE

3809-1 DC
Description: Open end bulge seat
Quantity: 80/box
Finish: Chrome
Thread: M14 x 1.5mm
Hex: 7 SPLINE
Overall length: 25.4mm
Seat diameter: 23.3mm
Operating key: 3800L



CLOSE END BULGE SEAT 7 SPLINE

3809-DLC
Description: Close end bulge seat
Quantity: 40/box
Finish: Chrome
Thread: M14 x 1.5mm
Hex: 7 SPLINE
Overall length: 51.7mm
Seat diameter: 23mm
Operating key: 3800L



3809-DLBK
Description: Close end bulge seat
Quantity: 40/box
Finish: Black Coat
Thread: M14 x 1.5mm
Hex: 7 SPLINE
Overall length: 51.7mm
Seat diameter: 23mm
Operating key: 3800L



3809-DC
Description: Close end bulge seat
Quantity: 80/box
Finish: Chrome
Thread: M14 x 1.5mm
Hex: 7 SPLINE
Overall length: 43.1mm
Seat diameter: 19.4mm
Operating key: 3800L



3809-DBK
Description: Close end bulge seat
Quantity: 80/box
Finish: Black Coat
Thread: M14 x 1.5mm
Hex: 7 SPLINE
Overall length: 43.1mm
Seat diameter: 19.4mm
Operating key: 3800L



TUNER NUT

2804
Description: Inverted hex tuner nut
Quantity: 50/box
Finish: Chrome
Thread: 1/2" 12mm
Hex: 32.6mm
Overall length: 20mm
Seat diameter: 2800
Operating key: 2800



2806
Description: Inverted hex tuner nut
Quantity: 50/box
Finish: Chrome
Thread: M12 x 1.25mm
Hex: 12mm
Overall length: 32.6mm
Seat diameter: 20mm
Operating key: 2800



2807
Description: Inverted hex tuner nut
Quantity: 50/box
Finish: Chrome
Thread: M12 x 1.5mm
Hex: 12mm
Overall length: 32.6mm
Seat diameter: 20mm
Operating key: 2800



2807 BK
Description: Inverted hex tuner nut
Quantity: 50/box
Finish: Black coat
Thread: M12 x 1.5mm
Hex: 12mm
Overall length: 32.6mm
Seat diameter: 20mm
Operating key: 2800



2807 L

Description: Inverted hex tuner nut
Quantity: 25/box
Finish: Chrome
Thread: M14 x 1.5mm
Hex: 15mm
Overall length: 45.4mm
Seat diameter: 20mm
Operating key: 2800L

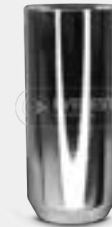

DUAL HEX SPLINE KEY

3800S
Description: 6 splines
Quantity: 30/box
Finish: Chrome
Hex: 17mm/19mm
Overall length: 73.1mm
Seat diameter: 20.4mm



3800
Description: 6 splines
Quantity: 20/box
Finish: Chrome/Black
Hex: 19mm/21mm
Overall length: 90mm
Seat diameter: 20.4mm



DUAL HEX TUNER KEY

2800
Quantity: 30/box
Finish: Chrome
Hex: 19mm/21mm
Key Hex: 12mm
Overall length: 57.9mm



2800L
Quantity: 30/box
Finish: Chrome
Hex: 19mm/21mm
Key Hex: 14.7mm
Overall length: 63.5mm



3800LD
Description: 6 splines
Quantity: 20/box
Finish: Chrome/Black
Hex: 21mm/22mm
Overall length: 82mm
Seat diameter: 23.3mm



3800L
Description: 7 splines
Quantity: 20/box
Finish: Chrome/Black
Hex: 21mm/22mm
Overall length: 82mm
Seat diameter: 23mm



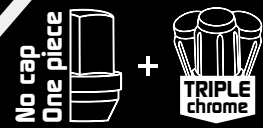

OEM NUTS

5330

Description: Close end bulge seat
Quantity: 30/box
Finish: Chrome
Thread: M14 x 1.5mm
Hex: 22mm
Overall length: 38.3mm
Seat diameter: 25mm



5330BK

Description: Close end bulge seat
Quantity: 30/box
Finish: Black coat
Thread: M14 x 1.5mm
Hex: 22mm
Overall length: 38.3mm
Seat diameter: 25mm



53045

Description: Close end shank seat
Quantity: 35/box
Finish: Chrome
Thread: M12 x 1.5mm
Hex: 19mm
Overall length: 43.2mm
Seat diameter: 20mm



53045BK

Description: Close end shank seat
Quantity: 35/box
Finish: Black coat
Thread: M12 x 1.5mm
Hex: 19mm
Overall length: 43.2mm
Seat diameter: 20mm



53085

Description: Close end bulge seat
Quantity: 40/box
Finish: Chrome
Thread: M14 x 1.5mm
Hex: 21mm
Overall length: 37.5mm
Seat diameter: 28.5mm



53085BK

Description: Close end bulge seat
Quantity: 40/box
Finish: Black coat
Thread: M14 x 1.5mm
Hex: 21mm
Overall length: 37.5mm
Seat diameter: 28.5mm



5305

Description: Close end bulge seat
Quantity: 35/box
Finish: Chrome
Thread: 9/16"
Hex: 22mm
Overall length: 37.8mm
Seat diameter: 25mm



5305BK

Description: Close end bulge seat
Quantity: 35/box
Finish: Black coat
Thread: 9/16"
Hex: 22mm
Overall length: 37.8mm
Seat diameter: 25mm

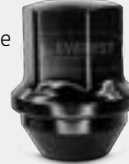

5301M

Description: Close end shank seat with washer
Quantity: 40/box
Finish: Chrome
Thread: M12 x 1.5mm
Hex: 21mm
Overall length: 36.8mm
Seat diameter: 18.3mm
Washer diameter: 30mm



OEM COVER RETAINING NUT

20075

Description: Open end Cap retaining thread
Quantity: 50/box
Finish: Zink plated
Thread: M12 x 1.5mm
Hex: 19mm
Overall length: 27mm
Seat diameter: 22.6mm
Cap retaining thread: M24 x 2.0mm



CLOSE END BULGE SEAT 6 SPLINE

3807-C

Description: Close end bulge seat
Quantity: 80/box
Finish: Chrome
Thread: M12 x 1.5mm
Hex: 33.2mm
Overall length: 20.2mm
Seat diameter: 3800/3800s
Operating key: 3800/3800s



3807-BK

Description: Close end bulge seat
Quantity: 80/box
Finish: Black coat
Thread: M12 x 1.5mm
Hex: 33.2mm
Overall length: 21mm
Seat diameter: 3800/3800s
Operating key: 3800/3800s



3807-LC

Description: Close end bulge seat
Quantity: 40/box
Finish: Chrome
Thread: M12 x 1.5mm
Hex: 50.5mm
Overall length: 23.1mm
Seat diameter: 3800LD
Operating key: 3800LD



3807-LBK

Description: Close end bulge seat
Quantity: 40/box
Finish: Black coat
Thread: M12 x 1.5mm
Hex: 50.5mm
Overall length: 23.1mm
Seat diameter: 3800LD
Operating key: 3800LD



OPEN END BULGE SEAT 6 SPLINE

3807-1C

Description: Open end bulge seat
Quantity: 100
Finish: Chrome
Thread: M12 x 1.5mm
Hex: 21mm
Overall length: 20.2mm
Seat diameter: 3800/3800s
Operating key: 3800/3800s



OPEN END BULGE SEAT 7 SPLINE

3809-1DC

Description: Open end bulge seat
Quantity: 80/box
Finish: Chrome
Thread: M14 x 1.5mm
Hex: 25.4mm
Overall length: 23.3mm
Seat diameter: 3800L
Operating key: 3800L



3810-1DC

Description: Open end bulge seat
Quantity: 80/box
Finish: Chrome
Thread: 9/16"
Hex: 25.3mm
Overall length: 23.3mm
Seat diameter: 3800L
Operating key: 3800L



OEM SIZE SPLINE BOLT 6 SPLINE

18435PC

Description: 60° Cone seat
Quantity: 50/box
Finish: Chrome
Hex: M12x 1.25mm
Thread: 6 spline
Overall length: 54mm
Thread length: 27mm
Seat diameter: 17.6mm
Operating key: 3800S /3800



18435PBK

Description: 60° Cone seat
Quantity: 50/box
Finish: Black coat
Hex: M12x 1.25mm
Thread: 6 spline
Overall length: 54mm
Thread length: 27mm
Seat diameter: 17.6mm
Operating key: 3800S /3800



OEM SIZE BOLT

1814

Description: 60° Cone seat
Quantity: 50/box
Finish: Chrome
Hex: M12x 1.25mm
Thread: 19mm
Overall length: 58mm
Thread length: 28mm
Seat diameter: 22.4mm



1814BK

Description: 60° Cone seat
Quantity: 50/box
Finish: Black coat
Hex: M12x 1.25mm
Thread: 19mm
Overall length: 58mm
Thread length: 28mm
Seat diameter: 22.4mm



1808L

Description: R13 ball seat
Quantity: 40/box
Finish: Chrome
Hex: M12x 1.5mm
Thread: 17mm
Overall length: 64.7mm
Thread length: 39mm
Seat diameter: 22mm



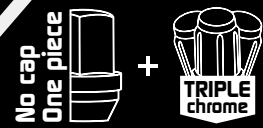

CLOSE END BULGE SEAT 7 SPLINE

3809-DC

Description: Close end bulge seat
Quantity: 80/box
Finish: Chrome
Thread: M14 x 1.5mm
Hex: 7 SPLINE
Overall length: 43.1mm
Seat diameter: 19.4mm
Operating key: 3800L



3809-DBK

Description: Close end bulge seat
Quantity: 80/box
Finish: Black Coat
Thread: M14 x 1.5mm
Hex: 7 SPLINE
Overall length: 43.1mm
Seat diameter: 19.4mm
Operating key: 3800L



3809-DLC

Description: Close end bulge seat
Quantity: 40/box
Finish: Chrome
Thread: M14 x 1.5mm
Hex: 7 SPLINE
Overall length: 51.7mm
Seat diameter: 23mm
Operating key: 3800L



3809-DLBK

Description: Close end bulge seat
Quantity: 40/box
Finish: Black Coat
Thread: M14 x 1.5mm
Hex: 7 SPLINE
Overall length: 51.7mm
Seat diameter: 23mm
Operating key: 3800L



3810-DC

Description: Close end bulge seat
Quantity: 40/box
Finish: Chrome
Thread: 9/16"
Hex: 7 SPLINE
Overall length: 43.1mm
Seat diameter: 19.4mm
Operating key: 3800L



3810-DBK

Description: Close end bulge seat
Quantity: 40/box
Finish: Black Coat
Thread: 9/16"
Hex: 7 SPLINE
Overall length: 43.1mm
Seat diameter: 19.4mm
Operating key: 3800L



TUNER NUT

2807

Description: Inverted hex tuner nut
Quantity: 50/box
Finish: Chrome
Thread: M12 x 1.5mm
Hex: 12mm
Overall length: 32.6mm
Seat diameter: 20mm
Operating key: 2800



2807 BK

Description: Inverted hex tuner nut
Quantity: 50/box
Finish: Black coat
Thread: M12 x 1.5mm
Hex: 12mm
Overall length: 32.6mm
Seat diameter: 20mm
Operating key: 2800



2807 L

Description: Inverted hex tuner nut
Quantity: 25/box
Finish: Chrome
Thread: M14 x 1.5mm
Hex: 15mm
Overall length: 45.4mm
Seat diameter: 20mm
Operating key: 2800L



DUAL HEX TUNER KEY

2800

Quantity: 30/box
Finish: Chrome
Hex: 19mm/21mm
Key Hex: 12mm
Overall length: 57.9mm



2800L

Quantity: 30/box
Finish: Chrome
Hex: 19mm/21mm
Key Hex: 14.7mm
Overall length: 63.5mm



DUAL HEX SPLINE KEY

3800S

Description: 6 splines
Quantity: 30/box
Finish: Chrome
Hex: 17mm/19mm
Overall length: 73.1mm
Seat diameter: 20.4mm



3800

Description: 6 splines
Quantity: 20/box
Finish: Chrome/Black
Hex: 19mm/21mm
Overall length: 90mm
Seat diameter: 20.4mm



3800L

Description: 7 splines
Quantity: 20/box
Finish: Chrome/Black
Hex: 21mm/22mm
Overall length: 82mm
Seat diameter: 23mm



OPEN END CONE SEAT

1307

Description: Open end 60° cone seat
Quantity: 100/box
Finish: Chrome
Thread: M12 x 1.5mm
Hex: 19mm
Overall length: 16.1mm



OPEN END BULGE SEAT

1307-IS

Description: Open end bulge seat
Quantity: 100/box
Finish: Chrome
Thread: M12 x 1.5mm
Hex: 19mm
Overall length: 21.4mm



CLOSE END CONE SEAT

1007

Description: Close end 60° cone seat
Quantity: 50/box
Finish: Chrome
Thread: M12 x 1.5mm
Hex: 21mm
Overall length: 35.3mm



CLOSE END BULGE SEAT

1907S

Description: Close end bulge seat
Quantity: 50/box
Finish: Chrome
Thread: M12 x 1.5mm
Hex: 19mm
Overall length: 34.7mm
Seat diameter: 22mm



OPEN END BULGE SEAT

3807-1C

Description: Open end bulge seat
Quantity: 100
Finish: Chrome
Thread: M12 x 1.5mm
Hex: 6 SPLINE
Overall length: 21mm
Seat diameter: 20.2mm
Operating key: 3800/3800s



CLOSE END BULGE SEAT

3807-C

Description: Close end bulge seat
Quantity: 80/box
Finish: Chrome
Thread: M12 x 1.5mm
Hex: 6 SPLINE
Overall length: 33.2mm
Seat diameter: 20.2mm
Operating key: 3800/3800s



3807-BK

Description: Close end bulge seat
Quantity: 80/box
Finish: Black coat
Thread: M12 x 1.5mm
Hex: 6 SPLINE
Overall length: 33.2mm
Seat diameter: 21mm
Operating key: 3800/3800s



1707BK

Description: Close end bulge seat
Quantity: 50/box
Finish: Black Coat
Thread: M12 x 1.5mm
Hex: 19mm
Overall length: 34.5mm
Seat diameter: 22mm



TUNER NUT

2807

Description: Inverted hex tuner nut
Quantity: 50/box
Finish: Chrome
Thread: M12 x 1.5mm
Hex: 12mm
Overall length: 32.6mm
Seat diameter: 20mm
Operating key: 2800



2807 BK

Description: Inverted hex tuner nut
Quantity: 50/box
Finish: Black coat
Thread: M12 x 1.5mm
Hex: 12mm
Overall length: 32.6mm
Seat diameter: 20mm
Operating key: 2800



DUAL HEX SPLINE KEY

3800S

Description: 6 splines
Quantity: 30/box
Finish: Chrome
Hex: 17mm/19mm
Overall length: 73.1mm
Seat diameter: 20.4mm



3800

Description: 6 splines
Quantity: 20/box
Finish: Chrome/Black
Hex: 19mm/21mm
Overall length: 90mm
Seat diameter: 20.4mm



DUAL HEX TUNER KEY

2800

Quantity: 30/box
Finish: Chrome
Hex: 19mm/21mm
Key Hex: 12mm
Overall length: 57.9mm



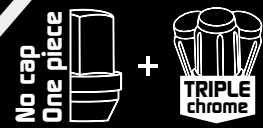

DEM NUTS

5330

Description: Close end bulge seat
Quantity: 30/box
Finish: Chrome
Thread: M14 x 1.5mm
Hex: 22mm
Overall length: 38.3mm
Seat diameter: 25mm



5330BK

Description: Close end bulge seat
Quantity: 30/box
Finish: Black coat
Thread: M14 x 1.5mm
Hex: 22mm
Overall length: 38.3mm
Seat diameter: 25mm



5304S

Description: Close end shank seat
Quantity: 35/box
Finish: Chrome
Thread: M12 x 1.5mm
Hex: 19mm
Overall length: 43.2mm
Seat diameter: 20mm



5304SBK

Description: Close end shank seat
Quantity: 35/box
Finish: Black coat
Thread: M12 x 1.5mm
Hex: 19mm
Overall length: 43.2mm
Seat diameter: 20mm



5305

Description: Close end bulge seat
Quantity: 35/box
Finish: Chrome
Thread: 9/16"
Hex: 22mm
Overall length: 37.8mm
Seat diameter: 25mm



5305BK

Description: Close end bulge seat
Quantity: 35/box
Finish: Black coat
Thread: 9/16"
Hex: 22mm
Overall length: 37.8mm
Seat diameter: 25mm



5304

Description: Close end shank seat
Quantity: 30/box
Finish: Chrome
Thread: M14 x 1.5mm
Hex: 21mm
Overall length: 42.6mm
Seat diameter: 20.9mm



5308

Description: Close end bulge seat
Quantity: 30/box
Finish: Chrome
Thread: M14 x 1.5mm
Hex: 22mm
Overall length: 47.6mm
Seat diameter: 26.5mm



5308BK

Description: Close end bulge seat
Quantity: 30/box
Finish: Black coat
Thread: M14 x 1.5mm
Hex: 22mm
Overall length: 47.6mm
Seat diameter: 26.5mm



5308S

Description: Close end bulge seat
Quantity: 40/box
Finish: Chrome
Thread: M14 x 1.5mm
Hex: 21mm
Overall length: 37.5mm
Seat diameter: 28.5mm



5308SBK

Description: Close end bulge seat
Quantity: 40/box
Finish: Black coat
Thread: M14 x 1.5mm
Hex: 21mm
Overall length: 37.5mm
Seat diameter: 28.5mm



5307

Description: Close end shank seat with washer
Quantity: 40/box
Finish: Chrome
Thread: M12 x 1.5mm
Hex: 21mm
Overall length: 37mm
Seat diameter: 18.3mm
Washer diameter: 30mm



DEM COVER RETAINING NUT

5307BK

Description: Close end shank seat with washer
Quantity: 40/box
Finish: Black coat
Thread: M12 x 1.5mm
Hex: 21mm
Overall length: 37mm
Seat diameter: 18.3mm
Washer diameter: 30mm



2007S

Description: Open end Cap retaining thread
Quantity: 50/box
Finish: Zink plated
Thread: M12 x 1.5mm
Hex: 19mm
Overall length: 27mm
Seat diameter: 22.6mm
Cap retaining thread: M24 x 2.0mm



DEM BOLTS

1814

Description: 60° Cone seat
Quantity: 50/box
Finish: Chrome
Hex: M12x 1.25mm
Thread: 19mm
Overall length: 58mm
Thread length: 28mm
Seat diameter: 22.4mm



1814BK

Description: 60° Cone seat
Quantity: 50/box
Finish: Black coat
Hex: M12x 1.25mm
Thread: 19mm
Overall length: 58mm
Thread length: 28mm
Seat diameter: 22.4mm



1809MS

Description: R14 ball seat
Quantity: 30/box
Finish: Dacromet coat
Hex: M14 x 1.5mm
Thread: 19mm
Overall length: 58.3mm
Thread length: 30mm
Seat diameter: 25.5mm



1809LMS

Description: R14 ball seat
Quantity: 35/box
Finish: Dacromet coat
Hex: M14 x 1.5mm
Thread: 19mm
Overall length: 73mm
Thread length: 22mm
Seat diameter: 26.5mm



DEM SIZE SPLINE BOLT 6 SPLINE

1843SPC

Description: 60° Cone seat
Quantity: 50/box
Finish: Chrome
Hex: M12x 1.25mm
Thread: 6 spline
Overall length: 54mm
Thread length: 27mm
Seat diameter: 17.6mm
Operating key: 3800S /3800



1843SPBK

Description: 60° Cone seat
Quantity: 50/box
Finish: Black coat
Hex: M12x 1.25mm
Thread: 6 spline
Overall length: 54mm
Thread length: 27mm
Seat diameter: 17.6mm
Operating key: 3800S /3800



OPEN END CONE SEAT

1307

Description: Open end 60° cone seat
Quantity: 100/box
Finish: Chrome
Thread: M12 x 1.5mm
Hex: 19mm
Overall length: 16.1mm



1324

Description: Open end 60° cone seat
Quantity: 100/box
Finish: Chrome
Thread: 1/2"
Hex: 21mm
Overall length: 16mm



1327

Description: Open end 60° cone seat
Quantity: 100/box
Finish: Chrome
Thread: M12 x 1.5mm
Hex: 21mm
Overall length: 16mm



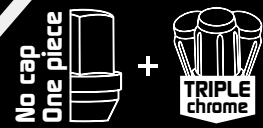

OPEN END BULGE SEAT

I312

Description: Open end bulge seat
Quantity: 70/box
Finish: Chrome
Thread: M14 x 1.5mm
Hex: 22mm
Overall length: 21.4mm



I307-1S

Description: Open end bulge seat
Quantity: 100/box
Finish: Chrome
Thread: M12 x 1.5mm
Hex: 19mm
Overall length: 21.4mm



I304-1

Description: Open end bulge seat
Quantity: 80/box
Finish: Chrome
Thread: 1/2"
Hex: 21mm
Overall length: 21mm



I309-1

Description: Open end bulge seat
Quantity: 80/box
Finish: Chrome
Thread: M14x 1.5mm
Hex: 21mm
Overall length: 21mm



OPEN END BULGE SEAT

I309-1S

Description: Open end bulge seat
Quantity: 100/box
Finish: Chrome
Thread: M14 x 1.5mm
Hex: 19mm
Overall length: 21.4mm



I313

Description: Open end bulge seat
Quantity: 50/box
Finish: Chrome
Thread: 9/16"
Hex: 22mm
Overall length: 21.4mm



CLOSE END CONE SEAT

I007

Description: Close end 60° cone seat
Quantity: 50/box
Finish: Chrome
Thread: M12 x 1.5mm
Hex: 21mm
Overall length: 35.3mm



CLOSE END BULGE SEAT

I907S

Description: Close end bulge seat
Quantity: 50/box
Finish: Chrome
Thread: M12 x 1.5mm
Hex: 19mm
Overall length: 34.7mm
Seat diameter: 22mm



I707BK

Description: Close end bulge seat
Quantity: 50/box
Finish: Black Coat
Thread: M12 x 1.5mm
Hex: 19mm
Overall length: 34.5mm
Seat diameter: 22mm



I907SL

Description: Close end bulge seat
Quantity: 40/box
Finish: Chrome
Thread: M12 x 1.5mm
Hex: 19mm
Overall length: 50mm
Seat diameter: 23mm



I909L

Description: Close end bulge seat
Quantity: 40/box
Finish: Chrome
Thread: M14 x 1.5mm
Hex: 21mm
Overall length: 45mm
Seat diameter: 24mm



I904L

Description: Close end bulge seat
Quantity: 40/box
Finish: Chrome
Thread: 1/2"
Hex: 21mm
Overall length: 45mm
Seat diameter: 24mm



I909SL

Description: Close end bulge seat
Quantity: 40/box
Finish: Chrome
Thread: M14 x 1.5mm
Hex: 19mm
Overall length: 50mm
Seat diameter: 23mm



I907

Description: Close end bulge seat
Quantity: 50/box
Finish: Chrome
Thread: M12 x 1.5mm
Hex: 21mm
Overall length: 34.7mm
Seat diameter: 24mm



I907BK

Description: Close end bulge seat
Quantity: 50/box
Finish: Black coat
Thread: M12 x 1.5mm
Hex: 21mm
Overall length: 34.7mm
Seat diameter: 24mm



DUPLEX ACORN

5401

Description: Close end Duplex Acorn
Quantity: 30/box
Finish: Chrome
Thread: M14 x 1.5mm
Hex: 22mm
Overall length: 48.2mm
Seat diameter: 25.5mm



5401BK

Description: Close end Duplex Acorn
Quantity: 30/box
Finish: Black coat
Thread: M14 x 1.5mm
Hex: 22mm
Overall length: 48.2mm
Seat diameter: 25.5mm



5402

Description: Close end Duplex Acorn
Quantity: 30/box
Finish: Chrome
Thread: 9/16"
Hex: 22mm
Overall length: 48.2mm
Seat diameter: 25.5mm



5400

Description: Close end Duplex Acorn
Quantity: 30/box
Finish: Chrome
Thread: 1/2"
Hex: 22mm
Overall length: 48.2mm
Seat diameter: 25.5mm



SHORT SHANK DUPLEX ACORN

3009

Description: Close end Duplex Acorn
Quantity: 30/box
Finish: Chrome
Thread: M14 x 1.5mm
Hex: 22mm
Overall length: 46.6mm
Seat diameter: 21.5mm



3010

Description: Close end Duplex Acorn
Quantity: 30/box
Finish: Chrome
Thread: 9/16"
Hex: 22mm
Overall length: 46.6mm
Seat diameter: 21.5mm



3004

Description: Close end Duplex Acorn
Quantity: 30/box
Finish: Chrome
Thread: 1/2"
Hex: 22mm
Overall length: 46.6mm
Seat diameter: 21.5mm



OPEN END BULGE SEAT 6 SPLINE

3807-1C

Description: Open end bulge seat
Quantity: 100
Finish: Chrome
Thread: M12 x 1.5mm
Hex: 19mm
Overall length: 21mm
Seat diameter: 20.2mm
Operating key: 3800/3800s



3809-1C

Description: Open end bulge seat
Quantity: 80/box
Finish: Chrome
Thread: M14 x 1.5mm
Hex: 21mm
Overall length: 24.5mm
Seat diameter: 23.1mm
Operating key: 3800LD



OPEN END BULGE SEAT 7 SPLINE

3809-1DC

Description: Open end bulge seat
Quantity: 80/box
Finish: Chrome
Thread: M14 x 1.5mm
Hex: 7 SPLINE
Overall length: 25.4mm
Seat diameter: 23.3mm
Operating key: 3800L



3810-1DC

Description: Open end bulge seat
Quantity: 80/box
Finish: Chrome
Thread: 9/16"
Hex: 7 SPLINE
Overall length: 25.3mm
Seat diameter: 23.3mm
Operating key: 3800L



CLOSE END BULGE SEAT 6 SPLINE

3807-C

Description: Close end bulge seat
Quantity: 80/box
Finish: Chrome
Thread: M12 x 1.5mm
Hex: 6 SPLINE
Overall length: 33.2mm
Seat diameter: 20.2mm
Operating key: 3800/3800s



3807-BK

Description: Close end bulge seat
Quantity: 80/box
Finish: Black coat
Thread: M12 x 1.5mm
Hex: 6 SPLINE
Overall length: 33.2mm
Seat diameter: 21mm
Operating key: 3800/3800s



3807-LC

Description: Close end bulge seat
Quantity: 40/box
Finish: Chrome
Thread: M12 x 1.5mm
Hex: 6 SPLINE
Overall length: 50.5mm
Seat diameter: 23.1mm
Operating key: 3800LD



3807-LBK

Description: Close end bulge seat
Quantity: 40/box
Finish: Black coat
Thread: M12 x 1.5mm
Hex: 6 SPLINE
Overall length: 50.5mm
Seat diameter: 23.1mm
Operating key: 3800LD



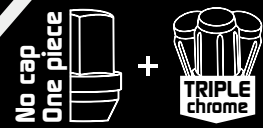

CLOSE END BULGE SEAT 6 SPLINE

3804-LC

Description: Close end bulge seat
Quantity: 40/box
Finish: Chrome
Thread: 1/2"
Hex: 6 SPLINE
Overall length: 50.5mm
Seat diameter: 23.1mm
Operating key: 3800LD



3804-LBK

Description: Close end bulge seat
Quantity: 40/box
Finish: Black coat
Thread: 1/2"
Hex: 6 SPLINE
Overall length: 50.5mm
Seat diameter: 23.1mm
Operating key: 3800LD



CLOSE END BULGE SEAT 7 SPLINE

3809-DC

Description: Close end bulge seat
Quantity: 80/box
Finish: Chrome
Thread: M14 x 1.5mm
Hex: 7 SPLINE
Overall length: 43.1mm
Seat diameter: 19.4mm
Operating key: 3800L



3809-DBK

Description: Close end bulge seat
Quantity: 80/box
Finish: Black Coat
Thread: M14 x 1.5mm
Hex: 7 SPLINE
Overall length: 43.1mm
Seat diameter: 19.4mm
Operating key: 3800L



3809-DLC

Description: Close end bulge seat
Quantity: 40/box
Finish: Chrome
Thread: M14 x 1.5mm
Hex: 7 SPLINE
Overall length: 51.7mm
Seat diameter: 23mm
Operating key: 3800L



3809-DLBK

Description: Close end bulge seat
Quantity: 40/box
Finish: Black Coat
Thread: M14 x 1.5mm
Hex: 7 SPLINE
Overall length: 51.7mm
Seat diameter: 23mm
Operating key: 3800L



3810-DC

Description: Close end bulge seat
Quantity: 40/box
Finish: Chrome
Thread: 9/16"
Hex: 7 SPLINE
Overall length: 43.1mm
Seat diameter: 19.4mm
Operating key: 3800L



3810-DBK

Description: Close end bulge seat
Quantity: 40/box
Finish: Black Coat
Thread: 9/16"
Hex: 7 SPLINE
Overall length: 43.1mm
Seat diameter: 19.4mm
Operating key: 3800L



TUNER NUT

2807

Description: Inverted hex tuner nut
Quantity: 50/box
Finish: Chrome
Thread: M12 x 1.5mm
Hex: 12mm
Overall length: 32.6mm
Seat diameter: 20mm
Operating key: 2800



2807 BK

Description: Inverted hex tuner nut
Quantity: 50/box
Finish: Black coat
Thread: M12 x 1.5mm
Hex: 12mm
Overall length: 32.6mm
Seat diameter: 20mm
Operating key: 2800



2807 L

Description: Inverted hex tuner nut
Quantity: 25/box
Finish: Chrome
Thread: M14 x 1.5mm
Hex: 15mm
Overall length: 45.4mm
Seat diameter: 20mm
Operating key: 2800L

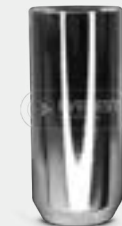

DUAL HEX SPLINE KEY

3800S

Description: 6 splines
Quantity: 30/box
Finish: Chrome
Hex: 17mm/19mm
Overall length: 73.1mm
Seat diameter: 20.4mm



3800

Description: 6 splines
Quantity: 20/box
Finish: Chrome/Black
Hex: 19mm/21mm
Overall length: 90mm
Seat diameter: 20.4mm



3800L

Description: 7 splines
Quantity: 20/box
Finish: Chrome/Black
Hex: 21mm/22mm
Overall length: 82mm
Seat diameter: 23mm



DUAL HEX TUNER KEY

2800

Quantity: 30/box
Finish: Chrome
Hex: 19mm/21mm
Key Hex: 12mm
Overall length: 57.9mm



2800L

Quantity: 30/box
Finish: Chrome
Hex: 19mm/21mm
Key Hex: 14.7mm
Overall length: 63.5mm



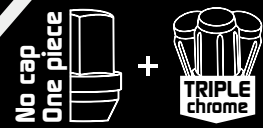

DEM NUTS

5330

Description: Close end bulge seat
Quantity: 30/box
Finish: Chrome
Thread: M14 x 1.5mm
Hex: 22mm
Overall length: 38.3mm
Seat diameter: 25mm



5330BK

Description: Close end bulge seat
Quantity: 30/box
Finish: Black coat
Thread: M14 x 1.5mm
Hex: 22mm
Overall length: 38.3mm
Seat diameter: 25mm



53045

Description: Close end shank seat
Quantity: 35/box
Finish: Chrome
Thread: M12 x 1.5mm
Hex: 19mm
Overall length: 43.2mm
Seat diameter: 20mm



53045BK

Description: Close end shank seat
Quantity: 35/box
Finish: Black coat
Thread: M12 x 1.5mm
Hex: 19mm
Overall length: 43.2mm
Seat diameter: 20mm



2010R

Description: Open end nut 60° cone seat
Quantity: 35/box
Finish: Zink plated
Thread: 9/16"
Hex: 15/16"
Overall length: 26mm
Seat diameter: 29.6mm



2014R

Description: Open end nut 60° cone seat
Quantity: 35/box
Finish: Zink plated
Thread: M14 x 1.5mm
Hex: 15/16"
Overall length: 26mm
Seat diameter: 29.6mm



5305

Description: Close end bulge seat
Quantity: 35/box
Finish: Chrome
Thread: 9/16"
Hex: 22mm
Overall length: 37.8mm
Seat diameter: 25mm



5305BK

Description: Close end bulge seat
Quantity: 35/box
Finish: Black coat
Thread: 9/16"
Hex: 22mm
Overall length: 37.8mm
Seat diameter: 25mm



DEM FLAT FLANGE

210R

Description: Variable flat faced flange
Quantity: 20/box
Finish: Black coat
Thread: 9/16"
Hex: 15/16"
Overall length: 28.8mm
Flange diameter: 40.6
Flange thickness: 7.5mm



214R

Description: Variable flat faced flange
Quantity: 20/box
Finish: Black coat
Thread: M14 x 1.5mm
Hex: 15/16"
Overall length: 28.8mm
Flange diameter: 40.6
Flange thickness: 7.5mm



DEM BOLT

1806FT

Description: 60° Cone seat
Quantity: 50/box
Finish: Chrome
Thread: M12 x 1.25 mm
Hex: 17mm
Overall length: 46.5mm
Thread length: 19mm
Seat diameter: 22mm



1806FTBK

Description: 60° Cone seat
Quantity: 50/box
Finish: Black coat
Thread: M12 x 1.25 mm
Hex: 17mm
Overall length: 46.5mm
Thread length: 19mm
Seat diameter: 22mm



1816PMT

Description: 60° Cone seat
Quantity: 30/box
Finish: Dacromet
Thread: M16x 1.5mm
Hex: 21mm
Overall length: 63.1mm
Thread length: 30mm
Seat diameter: 32mm



OPEN END BULGE SEAT

1312

Description: Open end bulge seat
Quantity: 70/box
Finish: Chrome
Thread: M14 x 1.5mm
Hex: 22mm
Overall length: 21.4mm



1313

Description: Open end bulge seat
Quantity: 70/box
Finish: Chrome
Thread: 9/16"
Hex: 22mm
Overall length: 21.4mm



1304-1

Description: Open end bulge seat
Quantity: 80/box
Finish: Chrome
Thread: 1/2"
Hex: 21mm
Overall length: 21mm



1307-1S

Description: Open end bulge seat
Quantity: 100/box
Finish: Chrome
Thread: M12 x 1.5mm
Hex: 19mm
Overall length: 21.4mm



OPEN END CONE SEAT

1307

Description: Open end 60° cone seat
Quantity: 100/box
Finish: Chrome
Thread: M12 x 1.5mm
Hex: 19mm
Overall length: 16.1mm



1324

Description: Open end 60° cone seat
Quantity: 100/box
Finish: Chrome
Thread: 1/2"
Hex: 21mm
Overall length: 16mm



CLOSE END CONE SEAT

1004

Description: Close end 60° cone seat
Quantity: 50/box
Finish: Chrome
Thread: 1/2"
Hex: 21mm
Overall length: 35.3mm



1007

Description: Close end 60° cone seat
Quantity: 50/box
Finish: Chrome
Thread: M12 x 1.5mm
Hex: 19mm
Overall length: 35.3mm



DUPLEX ACORN

5401

Description: Close end Duplex Acorn
Quantity: 30/box
Finish: Chrome
Thread: M14 x 1.5mm
Hex: 22mm
Overall length: 48.2mm
Seat diameter: 25.5mm



5401BK

Description: Close end Duplex Acorn
Quantity: 30/box
Finish: Black coat
Thread: M14 x 1.5mm
Hex: 22mm
Overall length: 48.2mm
Seat diameter: 25.5mm



5402

Description: Close end Duplex Acorn
Quantity: 30/box
Finish: Chrome
Thread: 9/16"
Hex: 22mm
Overall length: 48.2mm
Seat diameter: 25.5mm



5400

Description: Close end Duplex Acorn
Quantity: 30/box
Finish: Chrome
Thread: 1/2"
Hex: 22mm
Overall length: 48.2mm
Seat diameter: 25.5mm



SHORT SHANK DUPLEX ACORN

3009

Description: Close end Duplex Acorn
Quantity: 30/box
Finish: Chrome
Thread: M14 x 1.5mm
Hex: 22mm
Overall length: 46.6mm
Seat diameter: 21.5mm



3010

Description: Close end Duplex Acorn
Quantity: 30/box
Finish: Chrome
Thread: 9/16"
Hex: 22mm
Overall length: 46.6mm
Seat diameter: 21.5mm



3004

Description: Close end Duplex Acorn
Quantity: 30/box
Finish: Chrome
Thread: 1/2"
Hex: 22mm
Overall length: 46.6mm
Seat diameter: 21.5mm



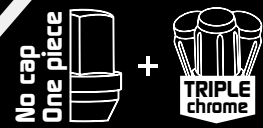

EPICOR & WHI
Ready Online!

OPEN END BULGE SEAT 6 SPLINE

3807-1C

Description: Open end bulge seat
Quantity: 100
Finish: Chrome
Thread: M12 x 1.5mm
Hex: 6 SPLINE
Overall length: 21mm
Seat diameter: 20.2mm
Operating key: 3800/3800s



3804-1C

Description: Open end bulge seat
Quantity: 100
Finish: Chrome
Thread: 1/2"
Hex: 6 SPLINE
Overall length: 21mm
Seat diameter: 20.2mm
Operating key: 3800/3800s



OPEN END BULGE SEAT 7 SPLINE

3809-1DC

Description: Open end bulge seat
Quantity: 80/box
Finish: Chrome
Thread: M14 x 1.5mm
Hex: 7 SPLINE
Overall length: 25.4mm
Seat diameter: 23.3mm
Operating key: 3800L



3810-1DC

Description: Open end bulge seat
Quantity: 80/box
Finish: Chrome
Thread: 9/16"
Hex: 7 SPLINE
Overall length: 25.3mm
Seat diameter: 23.3mm
Operating key: 3800L



CLOSE END BULGE SEAT 6 SPLINE

3807-LC

Description: Close end bulge seat
Quantity: 40/box
Finish: Chrome
Thread: M12 x 1.5mm
Hex: 6 SPLINE
Overall length: 50.5mm
Seat diameter: 23.1mm
Operating key: 3800LD



3807-LBK

Description: Close end bulge seat
Quantity: 40/box
Finish: Black coat
Thread: M12 x 1.5mm
Hex: 6 SPLINE
Overall length: 50.5mm
Seat diameter: 23.1mm
Operating key: 3800LD



3804-LC

Description: Close end bulge seat
Quantity: 40/box
Finish: Chrome
Thread: 1/2"
Hex: 6 SPLINE
Overall length: 50.5mm
Seat diameter: 23.1mm
Operating key: 3800LD



3804-LBK

Description: Close end bulge seat
Quantity: 40/box
Finish: Black coat
Thread: 1/2"
Hex: 6 SPLINE
Overall length: 50.5mm
Seat diameter: 23.1mm
Operating key: 3800LD



CLOSE END BULGE SEAT 7 SPLINE

3809-DC

Description: Close end bulge seat
Quantity: 80/box
Finish: Chrome
Thread: M14 x 1.5mm
Hex: 7 SPLINE
Overall length: 43.1mm
Seat diameter: 19.4mm
Operating key: 3800L



3809-DBK

Description: Close end bulge seat
Quantity: 80/box
Finish: Black Coat
Thread: M14 x 1.5mm
Hex: 7 SPLINE
Overall length: 43.1mm
Seat diameter: 19.4mm
Operating key: 3800L



3810-DC

Description: Close end bulge seat
Quantity: 40/box
Finish: Chrome
Thread: 9/16"
Hex: 7 SPLINE
Overall length: 43.1mm
Seat diameter: 19.4mm
Operating key: 3800L



3810-DBK

Description: Close end bulge seat
Quantity: 40/box
Finish: Black Coat
Thread: 9/16"
Hex: 7 SPLINE
Overall length: 43.1mm
Seat diameter: 19.4mm
Operating key: 3800L



TUNER NUT

2807 L

Description: Inverted hex tuner nut
Quantity: 25/box
Finish: Chrome
Thread: M14 x 1.5mm
Hex: 15mm
Overall length: 45.4mm
Seat diameter: 20mm
Operating key: 2800L



DUAL HEX SPLINE KEY

3800S

Description: 6 splines
Quantity: 30/box
Finish: Chrome
Hex: 17mm/19mm
Overall length: 73.1mm
Seat diameter: 20.4mm



3800

Description: 6 splines
Quantity: 20/box
Finish: Chrome/Black
Hex: 19mm/21mm
Overall length: 90mm
Seat diameter: 20.4mm



3800LD

Description: 6 splines
Quantity: 20/box
Finish: Chrome/Black
Hex: 21mm/22mm
Overall length: 82mm
Seat diameter: 23.3mm



DUAL HEX TUNER KEY

2800L

Quantity: 30/box
Finish: Chrome
Hex: 19mm/21mm
Key Hex: 14.7mm
Overall length: 63.5mm



3800L

Description: 7 splines
Quantity: 20/box
Finish: Chrome/Black
Hex: 21mm/22mm
Overall length: 82mm
Seat diameter: 23mm



3

**Times Chromed
Times The Satisfaction**

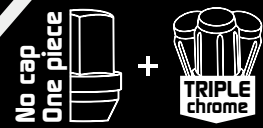

OEM BOLT

1806FT

Description:
60° Cone seat



Quantity: 50/box
Finish: Chrome
Thread: M12 x 1.25 mm
Hex: 17mm
Overall length: 46.5mm
Thread length: 19mm
Seat diameter: 22mm

1806FTBK

Description:
60° Cone seat



Quantity: 50/box
Finish: Black coat
Thread: M12 x 1.25 mm
Hex: 17mm
Overall length: 46.5mm
Thread length: 19mm
Seat diameter: 22mm

OPEN END CONE SEAT

1327

Description:
Open end 60° cone seat



Quantity: 100/box
Finish: Chrome
Thread: M12 x 1.5mm
Hex: 21mm
Overall length: 16mm

OPEN END BULGE SEAT

1307-1

Description:
Open end bulge seat



Quantity: 80/box
Finish: Chrome
Thread: M12 x 1.5mm
Hex: 21mm
Overall length: 21mm

CLOSE END CONE SEAT

1007

Description:
Close end 60° cone seat



Quantity: 50/box
Finish: Chrome
Thread: M12 x 1.5mm
Hex: 21mm
Overall length: 35.3mm

CLOSE END BULGE SEAT

1907

Description:
Close end bulge seat



Quantity: 50/box
Finish: Chrome
Thread: M12 x 1.5mm
Hex: 21mm
Overall length: 34.7mm
Seat diameter: 24mm

1907BK

Description:
Close end bulge seat



Quantity: 50/box
Finish: Black coat
Thread: M12 x 1.5mm
Hex: 21mm
Overall length: 34.7mm
Seat diameter: 24mm

OPEN END BULGE SEAT 6 SPLINE

3807-1C

Description:
Open end bulge seat



Quantity: 100
Finish: Chrome
Thread: M12 x 1.5mm
Hex: 6 SPLINE
Overall length: 21mm
Seat diameter: 20.2mm
Operating key: 3800/3800s

CLOSE END BULGE SEAT 6 SPLINE

3807-C

Description:
Close end bulge seat

Quantity: 80/box
Finish: Chrome

Thread: M12 x 1.5mm
Hex: 6 SPLINE
Overall length: 33.2mm
Seat diameter: 20.2mm
Operating key: 3800/3800s



3807-BK

Description:
Close end bulge seat

Quantity: 80/box
Finish: Black coat

Thread: M12 x 1.5mm
Hex: 6 SPLINE
Overall length: 33.2mm
Seat diameter: 21mm
Operating key: 3800/3800s



TUNER NUT

2807

Description:
Inverted hex tuner nut

Quantity: 50/box
Finish: Chrome

Thread: M12 x 1.5mm
Hex: 12mm
Overall length: 32.6mm
Seat diameter: 20mm
Operating key: 2800



2807 BK

Description:
Inverted hex tuner nut

Quantity: 50/box
Finish: Black coat

Thread: M12 x 1.5mm
Hex: 12mm
Overall length: 32.6mm
Seat diameter: 20mm
Operating key: 2800



DUAL HEX SPLINE KEY

3800S

Description:
6 splines



Quantity: 30/box
Finish: Chrome
Hex: 17mm/19mm
Overall length: 73.1mm
Seat diameter: 20.4mm

3800

Description:
6 splines



Quantity: 20/box
Finish: Chrome/Black
Hex: 19mm/21mm
Overall length: 90mm
Seat diameter: 20.4mm

DUAL HEX TUNER KEY

2800



Quantity: 30/box
Finish: Chrome
Hex: 19mm/21mm
Key Hex: 12mm
Overall length: 57.9mm



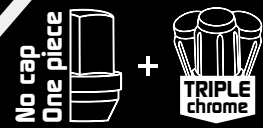

DEM NUTS

303

Description: Close end bulge seat
Quantity: 50/box
Finish: Chrome
Thread: M12 x 1.5mm
Hex: 19mm
Overall length: 32mm
Seat diameter: 22mm



303BK

Description: Close end bulge seat
Quantity: 50/box
Finish: Black coat
Thread: M12 x 1.5mm
Hex: 19mm
Overall length: 32mm
Seat diameter: 22mm



5308S

Description: Close end bulge seat
Quantity: 40/box
Finish: Chrome
Thread: M14 x 1.5mm
Hex: 21mm
Overall length: 37.5mm
Seat diameter: 28.5mm



5308SBK

Description: Close end bulge seat
Quantity: 40/box
Finish: Black coat
Thread: M14 x 1.5mm
Hex: 21mm
Overall length: 37.5mm
Seat diameter: 28.5mm



289

Description: Close end bulge seat
Quantity: 25/box
Finish: Chrome
Thread: M14 x 1.5mm
Hex: 21mm
Overall length: 41.8mm
Seat diameter: 26.9mm



289BK

Description: Close end bulge seat
Quantity: 25/box
Finish: Black coat
Thread: M14 x 1.5mm
Hex: 21mm
Overall length: 41.8mm
Seat diameter: 26.9mm



288

Description: Close end bulge seat
Quantity: 25/box
Finish: Chrome
Thread: M14 x 2.0mm
Hex: 21mm
Overall length: 54.6mm
Seat diameter: 28.4mm



288BK

Description: Close end bulge seat
Quantity: 25/box
Finish: Black coat
Thread: M14 x 2.0mm
Hex: 21mm
Overall length: 54.6mm
Seat diameter: 28.4mm



263

Description: Close end bulge seat
Quantity: 35/box
Finish: Chrome
Thread: M12 x 1.5mm
Hex: 19mm
Overall length: 34.8mm
Seat diameter: 21.3mm



290

Description: Close end bulge seat
Quantity: 25/box
Finish: Chrome
Thread: M14 x 2.0mm
Hex: 21mm
Overall length: 62.4mm
Seat diameter: 28.4mm



DEM COVER RETAINING NUT

2006F

Description: Open end bulge seat
Quantity: 35/box
Finish: Chrome
Thread: M14 x 1.5mm
Hex: 21mm
Overall length: 30.8mm
Seat diameter: 26.8mm



199

Description: Open end short shank seat
Quantity: 40/box
Finish: Zink plated
Thread: 1/2"
Hex: 19mm
Overall length: 31.4mm
Seat diameter: 21.5mm
Flange diameter: 28.3mm



2005F

Description: Open end bulge seat
Quantity: 35/box
Finish: Chrome
Thread: M14 x 2.0mm
Hex: 21mm
Overall length: 30.8mm
Seat diameter: 26.7mm



DEM FLAT FLANGE

2003F

Description: Open end variable flat faced flange
Quantity: 50/box
Finish: Black coat
Thread: M14 x 1.5mm
Hex: 21mm
Overall length: 21.5mm
Flange diameter: 29.6mm



127

Description: Open end variable flat faced flange
Quantity: 30/box
Finish: Black coat
Thread: 9/16"
Hex: 22mm
Overall length: 26.9mm
Flange diameter: 41mm
Flange thickness: 10mm



2004F

Description: Open end variable flat faced flange
Quantity: 50/box
Finish: Black coat
Thread: M14 x 2.0mm
Hex: 21mm
Overall length: 22mm
Flange diameter: 7.5mm



OPEN END CONE SEAT

1307

Description: Open end 60° cone seat
Quantity: 100/box
Finish: Chrome
Thread: M12 x 1.5mm
Hex: 19mm
Overall length: 16.1mm



1304

Description: Open end 60° cone seat
Quantity: 100/box
Finish: Chrome
Thread: 1/2"
Hex: 19mm
Overall length: 16.1mm



1324

Description: Open end 60° cone seat
Quantity: 100/box
Finish: Chrome
Thread: 1/2"
Hex: 21mm
Overall length: 16mm



OPEN END BULGE SEAT

1307-1S

Description: Open end bulge seat
Quantity: 100/box
Finish: Chrome
Thread: M12 x 1.5mm
Hex: 19mm
Overall length: 21.4mm



1309-1

Description: Open end bulge seat
Quantity: 80/box
Finish: Chrome
Thread: M14x 1.5mm
Hex: 21mm
Overall length: 21mm



1304-1S

Description: Open end bulge seat
Quantity: 100/box
Finish: Chrome
Thread: 1/2"
Hex: 19mm
Overall length: 21.4mm



1310-1

Description: Open end bulge seat
Quantity: 80/box
Finish: Chrome
Thread: 9/16"
Hex: 21mm
Overall length: 21mm



1350-1

Description: Open end bulge seat
Quantity: 80/box
Finish: Chrome
Thread: M14x2.0mm
Hex: 21mm
Overall length: 21mm



1304-1

Description: Open end bulge seat
Quantity: 80/box
Finish: Chrome
Thread: 1/2"
Hex: 21mm
Overall length: 21mm



1309-1S

Description: Open end bulge seat
Quantity: 100/box
Finish: Chrome
Thread: M14 x 1.5mm
Hex: 19mm
Overall length: 21.4mm



1307-1

Description: Open end bulge seat
Quantity: 80/box
Finish: Chrome
Thread: M12 x 1.5mm
Hex: 21mm
Overall length: 21mm



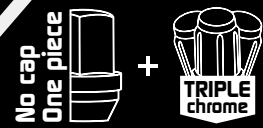

CLOSE END BULGE SEAT

<p>19075 Description: Close end bulge seat Quantity: 50/box Finish: Chrome Thread: M12 x 1.5mm Hex: 19mm Overall length: 34.7mm Seat diameter: 22mm</p> 	<p>1707BK Description: Close end bulge seat Quantity: 50/box Finish: Black Coat Thread: M12 x 1.5mm Hex: 19mm Overall length: 34.5mm Seat diameter: 22mm</p> 	<p>1909L Description: Close end bulge seat Quantity: 40/box Finish: Chrome Thread: M14 x 1.5mm Hex: 21mm Overall length: 45mm Seat diameter: 24mm</p> 	<p>19045L Description: Close end bulge seat Quantity: 40/box Finish: Chrome Thread: 1/2" Hex: 19mm Overall length: 50mm Seat diameter: 23mm</p> 
<p>1950L Description: Close end bulge Quantity: 40/box Finish: Chrome Thread: M14 x 2.0mm Hex: 21mm Overall length: 45mm Seat diameter: 24mm</p> 	<p>1904L Description: Close end bulge seat Quantity: 40/box Finish: Chrome Thread: 1/2" Hex: 21mm Overall length: 45mm Seat diameter: 24mm</p> 	<p>19075L Description: Close end bulge seat Quantity: 40/box Finish: Chrome Thread: M12 x 1.5mm Hex: 19mm Overall length: 50mm Seat diameter: 23mm</p> 	<p>19045 Description: Close end bulge seat Quantity: 50/box Finish: Chrome Thread: 1/2" Hex: 19mm Overall length: 35.6mm Seat diameter: 22mm</p> 
<p>19045BK Description: Close end bulge seat Quantity: 50/box Finish: Black Coat Thread: 1/2" Hex: 19mm Overall length: 35.6mm Seat diameter: 22mm</p> 	<p>1907 Description: Close end bulge seat Quantity: 50/box Finish: Chrome Thread: M12 x 1.5mm Hex: 21mm Overall length: 34.7mm Seat diameter: 24mm</p> 	<p>1907BK Description: Close end bulge seat Quantity: 50/box Finish: Black coat Thread: M12 x 1.5mm Hex: 21mm Overall length: 34.7mm Seat diameter: 24mm</p> 	<p>19095L Description: Close end bulge seat Quantity: 40/box Finish: Chrome Thread: M14 x 1.5mm Hex: 19mm Overall length: 50mm Seat diameter: 23mm</p> 

CLOSE END CONE SEAT

<p>1004 Description: Close end 60° cone seat Quantity: 50/box Finish: Chrome Thread: 1/2" Hex: 21mm Overall length: 35.3mm</p> 	<p>1007 Description: Close end 60° cone seat Quantity: 50/box Finish: Chrome Thread: M12 x 1.5mm Hex: 21mm Overall length: 35.3mm</p> 
---	--

OPEN END BULGE SEAT 6 SPLINE

<p>3807-1C Description: Open end bulge seat Quantity: 100 Finish: Chrome Thread: M12 x 1.5mm Hex: 6 SPLINE Overall length: 21mm Seat diameter: 20.2mm Operating key: 3800/3800s</p> 	<p>3804-1C Description: Open end bulge seat Quantity: 100 Finish: Chrome Thread: 1/2" Hex: 6 SPLINE Overall length: 21mm Seat diameter: 20.2mm Operating key: 3800/3800s</p> 
---	---

CLOSE END BULGE SEAT 6 SPLINE

<p>3807-C Description: Close end bulge seat Quantity: 80/box Finish: Chrome Thread: M12 x 1.5mm Hex: 6 SPLINE Overall length: 33.2mm Seat diameter: 20.2mm Operating key: 3800/3800s</p> 	<p>3807-BK Description: Close end bulge seat Quantity: 80/box Finish: Black coat Thread: M12 x 1.5mm Hex: 6 SPLINE Overall length: 33.2mm Seat diameter: 21mm Operating key: 3800/3800s</p> 	<p>3804-C Description: Close end bulge seat Quantity: 80/box Finish: Chrome Thread: 1/2" Hex: 6 SPLINE Overall length: 33.2mm Seat diameter: 20.2mm Operating key: 3800/3800s</p> 	<p>3804-BK Description: Close end bulge seat Quantity: 80/box Finish: Black coat Thread: 1/2" Hex: 6 SPLINE Overall length: 33.2mm Seat diameter: 21mm Operating key: 3800/3800s</p> 
<p>3804-LC Description: Close end bulge seat Quantity: 40/box Finish: Chrome Thread: 1/2" Hex: 6 SPLINE Overall length: 50.5mm Seat diameter: 23.1mm Operating key: 3800LD</p> 	<p>3804-LBK Description: Close end bulge seat Quantity: 40/box Finish: Black coat Thread: 1/2" Hex: 6 SPLINE Overall length: 50.5mm Seat diameter: 23.1mm Operating key: 3800LD</p> 	<p>3807-LC Description: Close end bulge seat Quantity: 40/box Finish: Chrome Thread: M12 x 1.5mm Hex: 6 SPLINE Overall length: 50.5mm Seat diameter: 23.1mm Operating key: 3800LD</p> 	<p>3807-LBK Description: Close end bulge seat Quantity: 40/box Finish: Black coat Thread: M12 x 1.5mm Hex: 6 SPLINE Overall length: 50.5mm Seat diameter: 23.1mm Operating key: 3800LD</p> 

DUAL HEX SPLINE KEY

<p>3800S Description: 6 splines Quantity: 30/box Finish: Chrome Hex: 17mm/19mm Overall length: 73.1mm Seat diameter: 20.4mm</p> 	<p>3800 Description: 6 splines Quantity: 20/box Finish: Chrome/Black Hex: 19mm/21mm Overall length: 90mm Seat diameter: 20.4mm</p> 	<p>3800L Description: 7 splines Quantity: 20/box Finish: Chrome/Black Hex: 21mm/22mm Overall length: 82mm Seat diameter: 23mm</p> 	<p>3800LD Description: 6 splines Quantity: 20/box Finish: Chrome/Black Hex: 21mm/22mm Overall length: 82mm Seat diameter: 23.3mm</p> 
--	---	--	---

DUAL HEX TUNER KEY

<p>2800 Quantity: 30/box Finish: Chrome Hex: 19mm/21mm Key Hex: 12mm Overall length: 57.9mm</p> 	<p>2800L Quantity: 30/box Finish: Chrome Hex: 19mm/21mm Key Hex: 14.7mm Overall length: 63.5mm</p> 
--	---

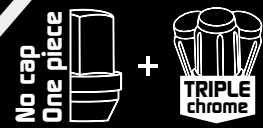

OPEN END BULGE SEAT 7 SPLINE

3809-1DC

Description: Open end bulge seat
Quantity: 80/box
Finish: Chrome
Thread: M14 x 1.5mm
Hex: 7 SPLINE
Overall length: 25.4mm
Seat diameter: 23.3mm
Operating key: 3800L



3810-1DC

Description: Open end bulge seat
Quantity: 80/box
Finish: Chrome
Thread: 9/16"
Hex: 7 SPLINE
Overall length: 25.3mm
Seat diameter: 23.3mm
Operating key: 3800L



3850-1DC

Description: Open end bulge seat
Quantity: 80/box
Finish: Chrome
Thread: M14 x 2.0mm
Hex: 7 SPLINE
Overall length: 25.4mm
Seat diameter: 23.3mm
Operating key: 3800L



CLOSE END BULGE SEAT 7 SPLINE

3809-DC

Description: Close end bulge seat
Quantity: 80/box
Finish: Chrome
Thread: M14 x 1.5mm
Hex: 7 SPLINE
Overall length: 43.1mm
Seat diameter: 19.4mm
Operating key: 3800L



3809-DBK

Description: Close end bulge seat
Quantity: 80/box
Finish: Black Coat
Thread: M14 x 1.5mm
Hex: 7 SPLINE
Overall length: 43.1mm
Seat diameter: 19.4mm
Operating key: 3800L



3810-DLC

Description: Close end bulge seat
Quantity: 40/box
Finish: Chrome
Thread: 9/16"
Hex: 7 SPLINE
Overall length: 51.7mm
Seat diameter: 23mm
Operating key: 3800L



3810-DLBK

Description: Close end bulge seat
Quantity: 40/box
Finish: Black coat
Thread: 9/16"
Hex: 7 SPLINE
Overall length: 51.7mm
Seat diameter: 23mm
Operating key: 3800L



3850-DLC

Description: Close end bulge seat
Quantity: 40/box
Finish: Chrome
Thread: M14 x 2.0mm
Hex: 7 SPLINE
Overall length: 51.7mm
Seat diameter: 23mm
Operating key: 3800L



3850-DLBK

Description: Close end bulge seat
Quantity: 40/box
Finish: Black coat
Thread: M14 x 2.0mm
Hex: 7 SPLINE
Overall length: 51.7mm
Seat diameter: 23mm
Operating key: 3800L



3809-DLC

Description: Close end bulge seat
Quantity: 40/box
Finish: Chrome
Thread: M14 x 1.5mm
Hex: 7 SPLINE
Overall length: 51.7mm
Seat diameter: 23mm
Operating key: 3800L



3809-DLBK

Description: Close end bulge seat
Quantity: 40/box
Finish: Black Coat
Thread: M14 x 1.5mm
Hex: 7 SPLINE
Overall length: 51.7mm
Seat diameter: 23mm
Operating key: 3800L



TUNER NUT

2804

Description: Inverted hex tuner nut
Quantity: 50/box
Finish: Chrome
Thread: 1/2"
Hex: 12mm
Overall length: 32.6mm
Seat diameter: 20mm
Operating key: 2800



2807L

Description: Inverted hex tuner nut
Quantity: 25/box
Finish: Chrome
Thread: M14 x 1.5mm
Hex: 15mm
Overall length: 45.4mm
Seat diameter: 20mm
Operating key: 2800L



2807

Description: Inverted hex tuner nut
Quantity: 50/box
Finish: Chrome
Thread: M12 x 1.5mm
Hex: 12mm
Overall length: 32.6mm
Seat diameter: 20mm
Operating key: 2800



2807BK

Description: Inverted hex tuner nut
Quantity: 50/box
Finish: Black coat
Thread: M12 x 1.5mm
Hex: 12mm
Overall length: 32.6mm
Seat diameter: 20mm
Operating key: 2800



DEM NUTS

5303M

Description: Close end 60° cone seat
Quantity: 80/box
Finish: Chrome
Thread: M12 x 1.5mm
Hex: 21mm
Overall length: 25.8mm
Seat diameter: 23.2mm



5303MBK

Description: Close end 60° cone seat
Quantity: 0/box
Finish: Black coat
Thread: M12 x 1.5mm
Hex: 21mm
Overall length: 25.8mm
Seat diameter: 23.2mm



133

Description: Close end 60° cone seat
Quantity: 50/box
Finish: Chrome
Thread: M12 x 1.5mm
Hex: 21mm
Overall length: 30mm



5307

Description: Close end shank seat with washer
Quantity: 40/box
Finish: Chrome
Thread: M12 x 1.5mm
Hex: 21mm
Overall length: 37mm
Seat diameter: 18.3mm
Washer diameter: 30mm



5307BK

Description: Close end shank seat with washer
Quantity: 40/box
Finish: Black coat
Thread: M12 x 1.5mm
Hex: 21mm
Overall length: 37mm
Seat diameter: 18.3mm
Washer diameter: 30mm



5301M

Description: Close end shank seat with washer
Quantity: 40/box
Finish: Chrome
Thread: M12 x 1.5mm
Hex: 21mm
Overall length: 36.8mm
Seat diameter: 18.3mm
Washer diameter: 30mm



OPEN END CONE SEAT

1327

Description: Open end 60° cone seat
Quantity: 100/box
Finish: Chrome
Thread: M12 x 1.5mm
Hex: 21
Overall length: 16mm



OPEN END BULGE SEAT

1307-1

Description: Open end bulge seat
Quantity: 80/box
Finish: Chrome
Thread: M12 x 1.5mm
Hex: 21mm
Overall length: 21mm



CLOSE END CONE SEAT

1007

Description: Close end 60° cone seat
Quantity: 50/box
Finish: Chrome
Thread: M12 x 1.5mm
Hex: 21mm
Overall length: 35.3mm



CLOSE END BULGE SEAT

1907

Description: Close end bulge seat
Quantity: 50/box
Finish: Chrome
Thread: M12 x 1.5mm
Hex: 21mm
Overall length: 34.7mm
Seat diameter: 24mm



1907BK

Description: Close end bulge seat
Quantity: 50/box
Finish: Black coat
Thread: M12 x 1.5mm
Hex: 21mm
Overall length: 34.7mm
Seat diameter: 24mm



OPEN END BULGE SEAT 6 SPLINE

Description: Open end bulge seat
Quantity: 100
Finish: Chrome
Thread: M12 x 1.5mm
Hex: 6 SPLINE
Overall length: 21mm
Seat diameter: 20.2mm
Operating key: 3800/3800s



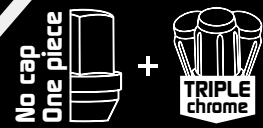

CLOSE END BULGE SEAT 6 SPLINE

<p>3807-C Description: Close end bulge seat Quantity: 80/box Finish: Chrome Thread: M12 x 1.5mm Hex: 6 SPLINE Overall length: 33.2mm Seat diameter: 20.2mm Operating key: 3800/3800s</p> 	<p>3807-BK Description: Close end bulge seat Quantity: 80/box Finish: Black coat Thread: M12 x 1.5mm Hex: 6 SPLINE Overall length: 33.2mm Seat diameter: 21mm Operating key: 3800/3800s</p> 
---	--

TUNER NUT

<p>2807 Description: Inverted hex tuner nut Quantity: 50/box Finish: Chrome Thread: M12 x 1.5mm Hex: 12mm Overall length: 32.6mm Seat diameter: 20mm Operating key: 2800</p> 	<p>2807 BK Description: Inverted hex tuner nut Quantity: 50/box Finish: Black coat Thread: M12 x 1.5mm Hex: 12mm Overall length: 32.6mm Seat diameter: 20mm Operating key: 2800</p> 
--	--

DUAL HEX SPLINE KEY

<p>3800S Description: 6 splines  Quantity: 30/box Finish: Chrome Hex: 17mm/19mm Overall length: 73.1mm Seat diameter: 20.4mm</p>	<p>3800 Description: 6 splines  Quantity: 20/box Finish: Chrome/Black Hex: 19mm/21mm Overall length: 90mm Seat diameter: 20.4mm</p>
---	--

DUAL HEX TUNER KEY

2800

Quantity: 30/box
Finish: Chrome
Hex: 19mm/21mm
Key Hex: 12mm
Overall length: 57.9mm



EVEREST WAREHOUSE
IS ALL ABOUT QUALITY.

DEM NUTS

<p>5308 Description: Close end bulge seat Quantity: 30/box Finish: Chrome Thread: M14 x 1.5mm Hex: 22mm Overall length: 47.6mm Seat diameter: 26.5mm</p> 	<p>5308BK Description: Close end bulge seat Quantity: 30/box Finish: Black coat Thread: M14 x 1.5mm Hex: 22mm Overall length: 47.6mm Seat diameter: 26.5mm</p> 
--	--

DEM COVER RETAINING NUT

<p>2007S Description: Open end Cap retaining thread Quantity: 50/box Finish: Zink plated Thread: M12 x 1.5mm Hex: 19mm Overall length: 27mm Seat diameter: 22.6mm Cap retaining thread: M24 x 2.0mm</p> 	<p>2009 Description: Open end Cap retaining thread Quantity: 40/box Finish: Zink plated Thread: M14 x 1.5mm Hex: 22mm Overall length: 29mm Seat diameter: 25mm Cap retaining thread: M27 x 2.0mm</p> 
--	---

DEM FLAT FLANGE

202
Description: Cap retaining variable flat faced flange

Quantity: 20/box
Finish: Black coat
Thread: M14 x 1.5mm
Hex: 22mm
Overall length: 33mm
Flange diameter: 45mm
Flange thickness: 10mm
Washer diameter: M27 x 2.0mm

OPEN END CONE SEAT

<p>I307 Description: Open end 60° cone seat Quantity: 100/box Finish: Chrome Thread: M12 x 1.5mm Hex: 19mm Overall length: 16.1mm</p> 	<p>I327 Description: Open end 60° cone seat Quantity: 100/box Finish: Chrome Thread: M12 x 1.5mm Hex: 21mm Overall length: 16mm</p> 
--	--

CLOSE END CONE SEAT

I007
Description: Close end 60° cone seat
Quantity: 50/box
Finish: Chrome
Thread: M12 x 1.5mm
Hex: 21mm
Overall length: 35.3mm



OPEN END BULGE SEAT

<p>I307-1S Description: Open end bulge seat Quantity: 100/box Finish: Chrome Thread: M12 x 1.5mm Hex: 19mm Overall length: 21.4mm</p> 	<p>I312 Description: Open end bulge seat Quantity: 70/box Finish: Chrome Thread: M14 x 1.5mm Hex: 22mm Overall length: 21.4mm</p> 	<p>I304-1S Description: Open end bulge seat Quantity: 100/box Finish: Chrome Thread: 1/2" Hex: 19mm Overall length: 21.4mm</p> 	<p>I307-1 Description: Open end bulge seat Quantity: 80/box Finish: Chrome Thread: M12 x 1.5mm Hex: 21mm Overall length: 21mm</p> 
--	--	---	--

GMC

GMC

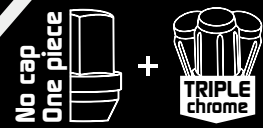

CLOSE END BULGE SEAT

1907S
Description: Close end bulge seat
Quantity: 50/box
Finish: Chrome
Thread: M12 x 1.5mm
Hex: 19mm
Overall length: 34.7mm
Seat diameter: 22mm



1707BK
Description: Close end bulge seat
Quantity: 50/box
Finish: Black Coat
Thread: M12 x 1.5mm
Hex: 19mm
Overall length: 34.5mm
Seat diameter: 22mm



1907SL
Description: Close end bulge seat
Quantity: 40/box
Finish: Chrome
Thread: M12 x 1.5mm
Hex: 19mm
Overall length: 50mm
Seat diameter: 23mm



1909L
Description: Close end bulge seat
Quantity: 40/box
Finish: Chrome
Thread: M14 x 1.5mm
Hex: 21mm
Overall length: 45mm
Seat diameter: 24mm



1904SL
Description: Close end bulge seat
Quantity: 40/box
Finish: Chrome
Thread: 1/2"
Hex: 19mm
Overall length: 50mm
Seat diameter: 23mm



5401
Description: Close end Duplex Acorn
Quantity: 30/box
Finish: Chrome
Thread: M14 x 1.5mm
Hex: 22mm
Overall length: 48.2mm
Seat diameter: 25.5mm



5401BK
Description: Close end Duplex Acorn
Quantity: 30/box
Finish: Black coat
Thread: M14 x 1.5mm
Hex: 22mm
Overall length: 48.2mm
Seat diameter: 25.5mm



5400
Description: Close end Duplex Acorn
Quantity: 30/box
Finish: Chrome
Thread: 1/2"
Hex: 22mm
Overall length: 48.2mm
Seat diameter: 25.5mm



SHORT SHANK DUPLEX ACORN

3009
Description: Close end Duplex Acorn
Quantity: 30/box
Finish: Chrome
Thread: M14 x 1.5mm
Hex: 22mm
Overall length: 46.6mm
Seat diameter: 21.5mm



3004
Description: Close end Duplex Acorn
Quantity: 30/box
Finish: Chrome
Thread: 1/2"
Hex: 22mm
Overall length: 46.6mm
Seat diameter: 21.5mm



OPEN END BULGE SEAT 6 SPLINE

3807-1C
Description: Open end bulge seat
Quantity: 100
Finish: Chrome
Thread: M12 x 1.5mm
Hex: 6 SPLINE
Overall length: 21mm
Seat diameter: 20.2mm
Operating key: 3800/3800s



3804-1C
Description: Open end bulge seat
Quantity: 100
Finish: Chrome
Thread: 1/2"
Hex: 6 SPLINE
Overall length: 21mm
Seat diameter: 20.2mm
Operating key: 3800/3800s



CLOSE END BULGE SEAT 6 SPLINE

3807-C
Description: Close end bulge seat
Quantity: 80/box
Finish: Chrome
Thread: M12 x 1.5mm
Hex: 6 SPLINE
Overall length: 33.2mm
Seat diameter: 20.2mm
Operating key: 3800/3800s



3807-BK
Description: Close end bulge seat
Quantity: 80/box
Finish: Black coat
Thread: M12 x 1.5mm
Hex: 6 SPLINE
Overall length: 33.2mm
Seat diameter: 21mm
Operating key: 3800/3800s



3804-LC
Description: Close end bulge seat
Quantity: 40/box
Finish: Chrome
Thread: 1/2"
Hex: 6 SPLINE
Overall length: 50.5mm
Seat diameter: 23.1mm
Operating key: 3800LD



3804-LBK
Description: Close end bulge seat
Quantity: 40/box
Finish: Black coat
Thread: 1/2"
Hex: 6 SPLINE
Overall length: 50.5mm
Seat diameter: 23.1mm
Operating key: 3800LD



CLOSE END BULGE SEAT 6 SPLINE

3807-LC
Description: Close end bulge seat
Quantity: 40/box
Finish: Chrome
Thread: M12 x 1.5mm
Hex: 6 SPLINE
Overall length: 50.5mm
Seat diameter: 23.1mm
Operating key: 3800LD



3807-LBK
Description: Close end bulge seat
Quantity: 40/box
Finish: Black coat
Thread: M12 x 1.5mm
Hex: 6 SPLINE
Overall length: 50.5mm
Seat diameter: 23.1mm
Operating key: 3800LD



OPEN END BULGE SEAT 7 SPLINE

3809-1DC
Description: Open end bulge seat
Quantity: 80/box
Finish: Chrome
Thread: M14 x 1.5mm
Hex: 7 SPLINE
Overall length: 25.4mm
Seat diameter: 23.3mm
Operating key: 3800L



CLOSE END BULGE SEAT 7 SPLINE

3809-DLC
Description: Close end bulge seat
Quantity: 40/box
Finish: Chrome
Thread: M14 x 1.5mm
Hex: 7 SPLINE
Overall length: 51.7mm
Seat diameter: 23mm
Operating key: 3800L



3809-DLBK
Description: Close end bulge seat
Quantity: 40/box
Finish: Black Coat
Thread: M14 x 1.5mm
Hex: 7 SPLINE
Overall length: 51.7mm
Seat diameter: 23mm
Operating key: 3800L



DUAL HEX TUNER KEY

2800
Quantity: 30/box
Finish: Chrome
Hex: 19mm/21mm
Key Hex: 12mm
Overall length: 57.9mm



2800L
Quantity: 30/box
Finish: Chrome
Hex: 19mm/21mm
Key Hex: 14.7mm
Overall length: 63.5mm



TUNER NUT

2807
Description: Inverted hex tuner nut
Quantity: 50/box
Finish: Chrome
Thread: M12 x 1.5mm
Hex: 12mm
Overall length: 32.6mm
Seat diameter: 20mm
Operating key: 2800



2807BK
Description: Inverted hex tuner nut
Quantity: 50/box
Finish: Black coat
Thread: M12 x 1.5mm
Hex: 12mm
Overall length: 32.6mm
Seat diameter: 20mm
Operating key: 2800



2807L
Description: Inverted hex tuner nut
Quantity: 25/box
Finish: Chrome
Thread: M14 x 1.5mm
Hex: 15mm
Overall length: 45.4mm
Seat diameter: 20mm
Operating key: 2800L

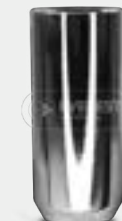

DUAL HEX SPLINE KEY

3800S
Description: 6 splines
Quantity: 30/box
Finish: Chrome
Hex: 17mm/19mm
Overall length: 73.1mm
Seat diameter: 20.4mm



3800
Description: 6 splines
Quantity: 20/box
Finish: Chrome/Black
Hex: 19mm/21mm
Overall length: 90mm
Seat diameter: 20.4mm



3800L
Description: 7 splines
Quantity: 20/box
Finish: Chrome/Black
Hex: 21mm/22mm
Overall length: 82mm
Seat diameter: 23mm



3800LD
Description: 6 splines
Quantity: 20/box
Finish: Chrome/Black
Hex: 21mm/22mm
Overall length: 82mm
Seat diameter: 23.3mm



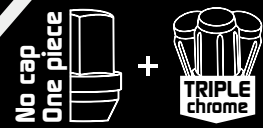

OEM Wheel Seat Application

OEM NUTS

I907HR

Description: Close end ball seat R12
Quantity: 40/box
Finish: Chrome
Thread: M12 x 1.5mm
Hex: 19mm
Overall length: 35mm
Seat diameter: 22mm



I909OR

Description: Close end ball seat R14
Quantity: 40/box
Finish: Chrome
Thread: M14 x 1.5mm
Hex: 22mm
Overall length: 36.2mm
Seat diameter: 26mm



075

Description: Close end ball seat R14
Quantity: 80/box
Finish: Chrome
Thread: M12 x 1.5mm
Hex: 19mm
Overall length: 23.6mm
Seat diameter: 21.9mm



5309

Description: Close end shank seat with washer
Quantity: 25/box
Finish: Chrome
Thread: M14 x 1.5mm
Hex: 22mm
Overall length: 48.4mm
Seat diameter: 20.8mm
Washer diameter: 34mm



OEM COVER RETAINING

I907WR

Description: Close end ball seat R12 with plastic washer
Quantity: 40/box
Finish: Chrome
Thread: M12 x 1.5mm
Hex: 19mm
Overall length: 32.8mm
Seat diameter: 22.8mm
Washer diameter: 28mm



I909WR

Description: Close end ball seat R14 with plastic washer
Quantity: 40/box
Finish: Chrome
Thread: M14 x 1.5mm
Hex: 22mm
Overall length: 36.2mm
Seat diameter: 26mm
Washer diameter: 28mm



OPEN END BALL SEAT

I307-IR

Description: Open end R12 ball seat
Quantity: 80/box
Finish: Chrome
Thread: M12 x 1.5mm
Hex: 19mm
Overall length: 21mm



I309-IR

Description: Open end R12 ball seat
Quantity: 80/box
Finish: Chrome
Thread: M14 x 1.5mm
Hex: 19mm
Overall length: 21mm



Aftermarket Wheel Seat Application

OPEN END CONE SEAT

I307

Description: Open end 60° cone seat
Quantity: 70/box
Finish: Chrome
Thread: M12 x 1.5mm
Hex: 19mm
Overall length: 16.1mm



OPEN END BULGE SEAT

I312

Description: Open end bulge seat
Quantity: 70/box
Finish: Chrome
Thread: M14 x 1.5mm
Hex: 22mm
Overall length: 21.4mm



I307-IS

Description: Open end bulge seat
Quantity: 100/box
Finish: Chrome
Thread: M12 x 1.5mm
Hex: 19mm
Overall length: 21.4mm



CLOSE END CONE SEAT

I007

Description: Close end 60° cone seat
Quantity: 50/box
Finish: Chrome
Thread: M12 x 1.5mm
Hex: 21mm
Overall length: 35.3mm



CLOSE END BULGE SEAT

I907S

Description: Close end bulge seat
Quantity: 50/box
Finish: Chrome
Thread: M12 x 1.5mm
Hex: 19mm
Overall length: 34.7mm
Seat diameter: 22mm



I707BK

Description: Close end bulge seat
Quantity: 50/box
Finish: Black Coat
Thread: M12 x 1.5mm
Hex: 19mm
Overall length: 34.5mm
Seat diameter: 22mm



I909

Description: Close end bulge seat
Quantity: 50/box
Finish: Chrome
Thread: M14 x 1.5mm
Hex: 21mm
Overall length: 34.7mm
Seat diameter: 24mm



I909L

Description: Close end bulge seat
Quantity: 40/box
Finish: Chrome
Thread: M14 x 1.5mm
Hex: 21mm
Overall length: 45mm
Seat diameter: 24mm

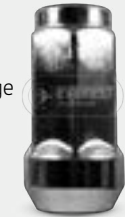

DUPLEX ACORN

540I

Description: Close end Duplex Acorn
Quantity: 30/box
Finish: Chrome
Thread: M14 x 1.5mm
Hex: 22mm
Overall length: 48.2mm
Seat diameter: 25.5mm



540IBK

Description: Close end Duplex Acorn
Quantity: 30/box
Finish: Black coat
Thread: M14 x 1.5mm
Hex: 22mm
Overall length: 48.2mm
Seat diameter: 25.5mm



SHORT SHANK DUPLEX ACORN

3009

Description: Close end Duplex Acorn
Quantity: 30/box
Finish: Chrome
Thread: M14 x 1.5mm
Hex: 22mm
Overall length: 46.6mm
Seat diameter: 21.5mm



OPEN END BULGE SEAT 6 SPLINE

3807-IC

Description: Open end bulge seat
Quantity: 100
Finish: Chrome
Thread: M12 x 1.5mm
Hex: 6 SPLINE
Overall length: 21mm
Seat diameter: 20.2mm
Operating key: 3800/3800s



CLOSE END BULGE SEAT 6 SPLINE

3807-C

Description: Close end bulge seat
Quantity: 80/box
Finish: Chrome
Thread: M12 x 1.5mm
Hex: 6 SPLINE
Overall length: 33.2mm
Seat diameter: 20.2mm
Operating key: 3800/3800s



3807-BK

Description: Close end bulge seat
Quantity: 80/box
Finish: Black coat
Thread: M12 x 1.5mm
Hex: 6 SPLINE
Overall length: 33.2mm
Seat diameter: 21mm
Operating key: 3800/3800s



OPEN END BULGE SEAT 7 SPLINE

3809-IDC

Description: Open end bulge seat
Quantity: 80/box
Finish: Chrome
Thread: M14 x 1.5mm
Hex: 7 SPLINE
Overall length: 25.4mm
Seat diameter: 23.3mm
Operating key: 3800L



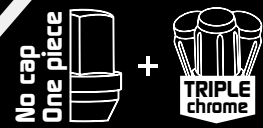

Aftermarket Wheel Seat Application

CLOSE END BULGE SEAT 7 SPLINE

3809-DC

Description:
Close end bulge seat

Quantity: 80/box
Finish: Chrome
Thread: M14 x 1.5mm
Hex: 7 SPLINE
Overall length: 43.1mm
Seat diameter: 19.4mm
Operating key: 3800L



3809-DBK

Description:
Close end bulge seat

Quantity: 80/box
Finish: Black Coat
Thread: M14 x 1.5mm
Hex: 7 SPLINE
Overall length: 43.1mm
Seat diameter: 19.4mm
Operating key: 3800L



3809-DLC

Description:
Close end bulge seat

Quantity: 40/box
Finish: Chrome
Thread: M14 x 1.5mm
Hex: 7 SPLINE
Overall length: 51.7mm
Seat diameter: 23mm
Operating key: 3800L



3809-DLBK

Description:
Close end bulge seat

Quantity: 40/box
Finish: Black Coat
Thread: M14 x 1.5mm
Hex: 7 SPLINE
Overall length: 51.7mm
Seat diameter: 23mm
Operating key: 3800L



TUNER NUT

2807

Description:
Inverted hex tuner nut

Quantity: 50/box
Finish: Chrome
Thread: M12 x 1.5mm
Hex: 12mm
Overall length: 32.6mm
Seat diameter: 20mm
Operating key: 2800



2807BK

Description:
Inverted hex tuner nut

Quantity: 50/box
Finish: Black coat
Thread: M12 x 1.5mm
Hex: 12mm
Overall length: 32.6mm
Seat diameter: 20mm
Operating key: 2800



2807L

Description:
Inverted hex tuner nut

Quantity: 25/box
Finish: Chrome
Thread: M14 x 1.5mm
Hex: 15mm
Overall length: 45.4mm
Seat diameter: 20mm
Operating key: 2800L



DUAL HEX TUNER KEY

2800



Quantity: 30/box
Finish: Chrome
Hex: 19mm/21mm
Key Hex: 12mm
Overall length: 57.9mm

DUAL HEX SPLINE KEY

3800S

Description:
6 splines

Quantity: 30/box
Finish: Chrome
Hex: 17mm/19mm
Overall length: 73.1mm
Seat diameter: 20.4mm



3800

Description:
6 splines

Quantity: 20/box
Finish: Chrome/Black
Hex: 19mm/21mm
Overall length: 90mm
Seat diameter: 20.4mm



3800L

Description:
7 splines

Quantity: 20/box
Finish: Chrome/Black
Hex: 21mm/22mm
Overall length: 82mm
Seat diameter: 23mm



2800L



Quantity: 30/box
Finish: Chrome
Hex: 19mm/21mm
Key Hex: 14.7mm
Overall length: 63.5mm

DEM COVER RETAINING NUT

2009

Description:
Open end Cap retaining thread

Quantity: 40/box
Finish: Zink plated
Thread: M14 x 1.5mm
Hex: 22mm
Overall length: 29mm
Seat diameter: 25mm
Cap retaining thread: M27 x 2.0mm



OPEN END BULGE SEAT

1312

Description:
Open end bulge seat

Quantity: 70/box
Finish: Chrome
Thread: M14 x 1.5mm
Hex: 22mm
Overall length: 21.4mm



CLOSE END BULGE SEAT

1909L

Description:
Close end bulge seat

Quantity: 40/box
Finish: Chrome
Thread: M14 x 1.5mm
Hex: 21mm
Overall length: 45mm
Seat diameter: 24mm



SHORT SHANK DUPLEX ACORN

3009

Description:
Close end Duplex Acorn

Quantity: 30/box
Finish: Chrome
Thread: M14 x 1.5mm
Hex: 22mm
Overall length: 46.6mm
Seat diameter: 21.5mm



DUPLEX ACORN

5401

Description:
Close end Duplex Acorn

Quantity: 30/box
Finish: Chrome
Thread: M14 x 1.5mm
Hex: 22mm
Overall length: 48.2mm
Seat diameter: 25.5mm



OPEN END BULGE SEAT 7 SPLINE

Description:
Open end bulge seat

Quantity: 80/box
Finish: Chrome
Thread: M14 x 1.5mm
Hex: 7 SPLINE
Overall length: 25.4mm
Seat diameter: 23.3mm
Operating key: 3800L



CLOSE END BULGE SEAT 7 SPLINE

3809-DC

Description:
Close end bulge seat

Quantity: 80/box
Finish: Chrome
Thread: M14 x 1.5mm
Hex: 7 SPLINE
Overall length: 43.1mm
Seat diameter: 19.4mm
Operating key: 3800L



3809-DBK

Description:
Close end bulge seat

Quantity: 80/box
Finish: Black Coat
Thread: M14 x 1.5mm
Hex: 7 SPLINE
Overall length: 43.1mm
Seat diameter: 19.4mm
Operating key: 3800L



TUNER NUT

2807L

Description:
Inverted hex tuner nut

Quantity: 25/box
Finish: Chrome
Thread: M14 x 1.5mm
Hex: 15mm
Overall length: 45.4mm
Seat diameter: 20mm
Operating key: 2800L



DUAL HEX SPLINE KEY

3800L

Description:
7 splines

Quantity: 20/box
Finish: Chrome/Black
Hex: 21mm/22mm
Overall length: 82mm
Seat diameter: 23mm



DUAL HEX TUNER KEY

2800L

Description:
7 splines

Quantity: 30/box
Finish: Chrome
Hex: 19mm/21mm
Key Hex: 14.7mm
Overall length: 63.5mm



HUMMER

HUMMER

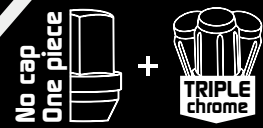

DEM NUTS

I707H

Description: Close end bulge seat
Quantity: 40/box
Finish: Chrome
Thread: M12 x 1.5mm
Hex: 19mm
Overall length: 31.3mm
Seat diameter: 24.2mm



5303M

Description: Close end 60° cone seat
Quantity: 80/box
Finish: Chrome
Thread: M12 x 1.5mm
Hex: 21mm
Overall length: 25.8mm
Seat diameter: 23.2mm



5303MBK

Description: Close end 60° cone seat
Quantity: 0/box
Finish: Black coat
Thread: M12 x 1.5mm
Hex: 21mm
Overall length: 25.8mm
Seat diameter: 23.2mm



5307

Description: Close end shank seat with washer
Quantity: 40/box
Finish: Chrome
Thread: M12 x 1.5mm
Hex: 21mm
Overall length: 37mm
Seat diameter: 18.3mm
Washer diameter: 30mm



DEM COVER RETAINING NUT

5307BK

Description: Close end shank seat with washer
Quantity: 40/box
Finish: Black coat
Thread: M12 x 1.5mm
Hex: 21mm
Overall length: 37mm
Seat diameter: 18.3mm
Washer diameter: 30mm



I707CP

Description: Close end bulge seat with plastic washer
Quantity: 40/box
Finish: Chrome
Thread: M12 x 1.5mm
Hex: 21mm
Overall length: 33mm
Seat diameter: 23.7mm
Seat diameter: 27.7mm



CLOSE END BULGE SEAT

1907

Description: Close end bulge seat
Quantity: 50/box
Finish: Chrome
Thread: M12 x 1.5mm
Hex: 21mm
Overall length: 34.7mm
Seat diameter: 24mm



1907BK

Description: Close end bulge seat
Quantity: 50/box
Finish: Black coat
Thread: M12 x 1.5mm
Hex: 21mm
Overall length: 34.7mm
Seat diameter: 24mm



TUNER NUT

2807

Description: Inverted hex tuner nut
Quantity: 50/box
Finish: Chrome
Thread: M12 x 1.5mm
Hex: 12mm
Overall length: 32.6mm
Seat diameter: 20mm
Operating key: 2800



2807 BK

Description: Inverted hex tuner nut
Quantity: 50/box
Finish: Black coat
Thread: M12 x 1.5mm
Hex: 12mm
Overall length: 32.6mm
Seat diameter: 20mm
Operating key: 2800



OPEN END BULGE SEAT 6 SPLINE

3807-1C

Description: Open end bulge seat
Quantity: 100
Finish: Chrome
Thread: M12 x 1.5mm
Hex: 6 SPLINE
Overall length: 21mm
Seat diameter: 20.2mm
Operating key: 3800/3800s



CLOSE END BULGE SEAT 6 SPLINE

3807-C

Description: Close end bulge seat
Quantity: 80/box
Finish: Chrome
Thread: M12 x 1.5mm
Hex: 6 SPLINE
Overall length: 33.2mm
Seat diameter: 20.2mm
Operating key: 3800/3800s



3807-BK

Description: Close end bulge seat
Quantity: 80/box
Finish: Black coat
Thread: M12 x 1.5mm
Hex: 6 SPLINE
Overall length: 33.2mm
Seat diameter: 21mm
Operating key: 3800/3800s



DUAL HEX SPLINE KEY

3800S

Description: 6 splines
Quantity: 30/box
Finish: Chrome
Hex: 17mm/19mm
Overall length: 73.1mm
Seat diameter: 20.4mm



3800

Description: 6 splines
Quantity: 20/box
Finish: Chrome/Black
Hex: 19mm/21mm
Overall length: 90mm
Seat diameter: 20.4mm



DUAL HEX TUNER KEY

2800

Quantity: 30/box
Finish: Chrome
Hex: 19mm/21mm
Key Hex: 12mm
Overall length: 57.9mm



OPEN END CONE SEAT

I307

Description: Open end 60° cone seat
Quantity: 100/box
Finish: Chrome
Thread: M12 x 1.5mm
Hex: 19mm
Overall length: 16.1mm



OPEN END BULGE SEAT

I307-1

Description: Open end bulge seat
Quantity: 100/box
Finish: Chrome
Thread: M12 x 1.5mm
Hex: 21mm
Overall length: 21mm



CLOSE END CONE SEAT

I007

Description: Close end 60° cone seat
Quantity: 50/box
Finish: Chrome
Thread: M12 x 1.5mm
Hex: 21mm
Overall length: 35.3mm



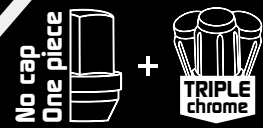

DEM NUTS

5306

Description: Close end shank seat with washer

Quantity: 40/box
Finish: Chrome
Thread: M12 x 1.25mm
Hex: 21mm
Overall length: 37mm
Seat diameter: 18.3mm
Washer diameter: 30mm



5306BK

Description: Close end shank seat with washer

Quantity: 40/box
Finish: Black coat
Thread: M12 x 1.25mm
Hex: 21mm
Overall length: 37mm
Seat diameter: 18.3mm
Washer diameter: 30mm



5306L

Description: Close end shank seat with washer

Quantity: 35/box
Finish: Chrome
Thread: M12 x 1.25mm
Hex: 21mm
Overall length: 47.9mm
Seat diameter: 18.3mm
Washer diameter: 30mm



114

Description: Close end 60° Cone seat

Quantity: 50/box
Finish: Chrome
Thread: M12 x 1.25mm
Hex: 21mm
Overall length: 30mm



CLOSE END BULGE SEAT

1906

Description: Close end bulge seat

Quantity: 50/box
Finish: Chrome
Thread: M12 x 1.25mm
Hex: 21mm
Overall length: 34.7mm
Seat diameter: 24mm



1906SL

Description: Close end bulge seat

Quantity: 40/box
Finish: Chrome
Thread: M12 x 1.25mm
Hex: 19mm
Overall length: 50mm
Seat diameter: 23mm



OPEN END BULGE SEAT 6 SPLINE

3806-1C

Description: Open end bulge seat

Quantity: 100
Finish: Chrome
Thread: M12 x 1.25mm
Hex: 19mm
Overall length: 21mm
Seat diameter: 20.2mm
Operating key: 3800/3800s



DEM BOLT

18095 I

Description: R13 Ball seat

Quantity: 50/box
Finish: Chrome
Thread: M14 x 1.5mm
Hex: 17mm
Overall length: 50mm
Thread length: 25mm
Seat diameter: 23mm



18095 I BK

Description: R13 Ball seat

Quantity: 50/box
Finish: Black coat
Thread: M14 x 1.5mm
Hex: 17mm
Overall length: 50mm
Thread length: 25mm
Seat diameter: 23mm



DEM SPLINE BOLT 6 SPLINE

18095 I PC

Description: R13 Ball seat

Quantity: 50/box
Finish: Chrome
Thread: M14 x 1.5mm
Hex: 6 spline
Overall length: 50mm
Thread length: 25mm
Seat diameter: 23mm
Operating key: 3800/3800s



18095 I PBK

Description: R13 Ball seat

Quantity: 50/box
Finish: Black coat
Thread: M14 x 1.5mm
Hex: 6 spline
Overall length: 50mm
Thread length: 25mm
Seat diameter: 23mm
Operating key: 3800/3800s



CLOSE END BULGE SEAT 6 SPLINE

3806-C

Description: Close end bulge seat

Quantity: 80/box
Finish: Chrome
Thread: M12 x 1.25mm
Hex: 6 SPLINE
Overall length: 33.2mm
Seat diameter: 20.2mm
Operating key: 3800/3800s



3806-BK

Description: Close end bulge seat

Quantity: 80/box
Finish: Black coat
Thread: M12 x 1.25mm
Hex: 6 SPLINE
Overall length: 33.2mm
Seat diameter: 21mm
Operating key: 3800/3800s



TUNER NUT

2806

Description: Inverted hex tuner nut

Quantity: 50/box
Finish: Chrome
Thread: M12 x 1.25mm
Hex: 12mm
Overall length: 32.6mm
Seat diameter: 20mm
Operating key: 2800



OPEN END CONE SEAT

1326

Description: Open end 60° cone seat

Quantity: 100/box
Finish: Chrome
Thread: M12 x 1.25mm
Hex: 21mm
Overall length: 16mm



OPEN END BULGE SEAT

1306-1

Description: Open end bulge seat

Quantity: 80/box
Finish: Chrome
Thread: M12 x 1.25mm
Hex: 21mm
Overall length: 21mm



CLOSE END CONE SEAT

1006

Description: Close end 60° cone seat

Quantity: 50/box
Finish: Chrome
Thread: M12 x 1.25mm
Hex: 21mm
Overall length: 35.3mm



DUAL HEX 6 SPLINE KEY

3800S

Description: 6 splines

Quantity: 30/box
Finish: Chrome
Hex: 17mm/19mm
Overall length: 73.1mm
Seat diameter: 20.4mm



3800

Description: 6 splines

Quantity: 20/box
Finish: Chrome/Black
Hex: 19mm/21mm
Overall length: 90mm
Seat diameter: 20.4mm



DUAL HEX TUNER KEY

2800

Quantity: 30/box
Finish: Chrome
Hex: 19mm/21mm
Key Hex: 12mm
Overall length: 57.9mm



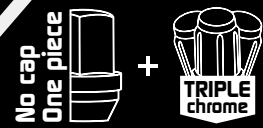

DEM COVER RETAINING NUT

I707CP

Description: Close end bulge seat with plastic washer
Quantity: 40/box
Finish: Chrome
Thread: M12 x 1.5mm
Hex: 21mm
Overall length: 33mm
Seat diameter: 23.7mm
Seat diameter: 27.7mm



DEM NUTS

I707H

Description: Close end bulge seat
Quantity: 40/box
Finish: Chrome
Thread: M12 x 1.5mm
Hex: 19mm
Overall length: 31.3mm
Seat diameter: 24.2mm



CLOSE END CONE SEAT

I007

Description: Close end 60° cone seat
Quantity: 50/box
Finish: Chrome
Thread: M12 x 1.5mm
Hex: 21mm
Overall length: 35.3mm



CLOSE END BULGE SEAT

I9075

Description: Close end bulge seat
Quantity: 50/box
Finish: Chrome
Thread: M12 x 1.5mm
Hex: 19mm
Overall length: 34.7mm
Seat diameter: 22mm



I707BK

Description: Close end bulge seat
Quantity: 50/box
Finish: Black Coat
Thread: M12 x 1.5mm
Hex: 19mm
Overall length: 34.5mm
Seat diameter: 22mm



OPEN END CONE SEAT

I307

Description: Open end 60° cone seat
Quantity: 100/box
Finish: Chrome
Thread: M12 x 1.5mm
Hex: 19mm
Overall length: 16.1mm



OPEN END BULGE SEAT

I307-IS

Description: Open end bulge seat
Quantity: 100/box
Finish: Chrome
Thread: M12 x 1.5mm
Hex: 19mm
Overall length: 21.4mm



OPEN END BULGE SEAT 6 SPLINE

3807-1C

Description: Open end bulge seat
Quantity: 100
Finish: Chrome
Thread: M12 x 1.5mm
Hex: 21mm
Overall length: 21mm
Seat diameter: 20.2mm
Operating key: 3800/3800s



CLOSE END BULGE SEAT 6 SPLINE

3807-C

Description: Close end bulge seat
Quantity: 80/box
Finish: Chrome
Thread: M12 x 1.5mm
Hex: 33.2mm
Overall length: 33.2mm
Seat diameter: 20.2mm
Operating key: 3800/3800s



3807-BK

Description: Close end bulge seat
Quantity: 80/box
Finish: Black coat
Thread: M12 x 1.5mm
Hex: 33.2mm
Overall length: 33.2mm
Seat diameter: 21mm
Operating key: 3800/3800s



TUNER NUT

2807

Description: Inverted hex tuner nut
Quantity: 50/box
Finish: Chrome
Thread: M12 x 1.5mm
Hex: 12mm
Overall length: 32.6mm
Seat diameter: 20mm
Operating key: 2800



2807 BK

Description: Inverted hex tuner nut
Quantity: 50/box
Finish: Black coat
Thread: M12 x 1.5mm
Hex: 12mm
Overall length: 32.6mm
Seat diameter: 20mm
Operating key: 2800



DUAL HEX SPLINE KEY

3800S

Description: 6 splines
Quantity: 30/box
Finish: Chrome
Hex: 17mm/19mm
Overall length: 73.1mm
Seat diameter: 20.4mm



3800

Description: 6 splines
Quantity: 20/box
Finish: Chrome/Black
Hex: 19mm/21mm
Overall length: 90mm
Seat diameter: 20.4mm



DUAL HEX TUNER KEY

2800

Quantity: 30/box
Finish: Chrome
Hex: 19mm/21mm
Key Hex: 12mm
Overall length: 57.9mm



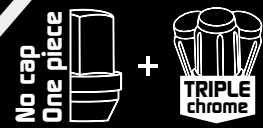

OEM Wheel Seat Application

CLOSE END CONE SEAT

20015

Description: Close end variable 60° cone seat nut
Quantity: 40/box
Finish: Chrome
Thread: M14 x 1.5mm
Hex: 21mm
Overall length: 35mm
Seat Diameter: 28mm



980

Description: Close end shank seat with washer
Quantity: 40/box
Finish: Chrome
Thread: M12 x 1.5mm
Hex: 19mm
Overall length: 40mm
Seat Diameter: 18.5mm
Washer Diameter: 30.2mm



Aftermarket Wheel Seat Application

OPEN END CONE SEAT

1307

Description: Open end 60° cone seat
Quantity: 100/box
Finish: Chrome
Thread: M12 x 1.5mm
Hex: 19mm
Overall length: 16.1mm



1324

Description: Open end 60° cone seat
Quantity: 100/box
Finish: Chrome
Thread: 1/2"
Hex: 21mm
Overall length: 16mm



CLOSE END CONE SEAT

1004

Description: Close end 60° cone seat
Quantity: 50/box
Finish: Chrome
Thread: 1/2"
Hex: 21mm
Overall length: 35.3mm



1007

Description: Close end 60° cone seat
Quantity: 50/box
Finish: Chrome
Thread: M12 x 1.5mm
Hex: 21mm
Overall length: 35.3mm



OPEN END BULGE SEAT

1307-1S

Description: Open end bulge seat
Quantity: 100/box
Finish: Chrome
Thread: M12 x 1.5mm
Hex: 19mm
Overall length: 21.4mm



1309-1

Description: Open end bulge seat
Quantity: 80/box
Finish: Chrome
Thread: M14x 1.5mm
Hex: 21mm
Overall length: 21mm



1304-1

Description: Open end bulge seat
Quantity: 80/box
Finish: Chrome
Thread: 1/2"
Hex: 21mm
Overall length: 21mm



Aftermarket Wheel Seat Application

SHORT SHANK DUPLEX ACORN

3009

Description: Close end Duplex Acorn
Quantity: 30/box
Finish: Chrome
Thread: M14 x 1.5mm
Hex: 22mm
Overall length: 46.6mm
Seat diameter: 21.5mm



CLOSE END BULGE SEAT

19075

Description: Close end bulge seat
Quantity: 50/box
Finish: Chrome
Thread: M12 x 1.5mm
Hex: 19mm
Overall length: 34.7mm
Seat diameter: 22mm



1909

Description: Close end bulge
Quantity: 50/box
Finish: Chrome
Thread: M14 x 1.5mm
Hex: 21mm
Overall length: 34.7mm
Seat diameter: 24mm



1904L

Description: Close end bulge seat
Quantity: 40/box
Finish: Chrome
Thread: 1/2"
Hex: 21mm
Overall length: 45mm
Seat diameter: 24mm



DUPLEX ACORN

5401

Description: Close end Duplex Acorn
Quantity: 30/box
Finish: Chrome
Thread: M14 x 1.5mm
Hex: 22mm
Overall length: 48.2mm
Seat diameter: 25.5mm



5401BK

Description: Close end Duplex Acorn
Quantity: 30/box
Finish: Black coat
Thread: M14 x 1.5mm
Hex: 22mm
Overall length: 48.2mm
Seat diameter: 25.5mm



OPEN END BULGE SEAT 6 SPLINE

3807-1C

Description: Open end bulge seat
Quantity: 100
Finish: Chrome
Thread: M12 x 1.5mm
Hex: 6 SPLINE
Overall length: 21mm
Seat diameter: 20.2mm
Operating key: 3800/3800s



3804-1C

Description: Open end bulge seat
Quantity: 100
Finish: Chrome
Thread: 1/2"
Hex: 6 SPLINE
Overall length: 21mm
Seat diameter: 20.2mm
Operating key: 3800/3800s



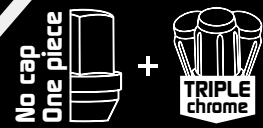

Aftermarket Wheel Seat Application

CLOSE END BULGE SEAT 6 SPLINE

3804-LC

Description: Close end bulge seat

Quantity: 40/box

Finish: Chrome

Thread: 1/2"

Hex: 6 SPLINE

Overall length: 50.5mm

Seat diameter: 23.1mm

Operating key: 3800LD



3804-LBK

Description: Close end bulge seat

Quantity: 40/box

Finish: Black coat

Thread: 1/2"

Hex: 6 SPLINE

Overall length: 50.5mm

Seat diameter: 23.1mm

Operating key: 3800LD



3807-LC

Description: Close end bulge seat

Quantity: 40/box

Finish: Chrome

Thread: M12 x 1.5mm

Hex: 6 SPLINE

Overall length: 50.5mm

Seat diameter: 23.1mm

Operating key: 3800LD



3807-LBK

Description: Close end bulge seat

Quantity: 40/box

Finish: Black coat

Thread: M12 x 1.5mm

Hex: 6 SPLINE

Overall length: 50.5mm

Seat diameter: 23.1mm

Operating key: 3800LD



OPEN END BULGE SEAT 7 SPLINE

3809-IDC

Description: Open end bulge seat

Quantity: 80/box

Finish: Chrome

Thread: M14 x 1.5mm

Hex: 7 SPLINE

Overall length: 25.4mm

Seat diameter: 23.3mm

Operating key: 3800L



CLOSE END BULGE SEAT 7 SPLINE

3809-DC

Description: Close end bulge seat

Quantity: 80/box

Finish: Chrome

Thread: M14 x 1.5mm

Hex: 7 SPLINE

Overall length: 43.1mm

Seat diameter: 19.4mm

Operating key: 3800L



3809-DBK

Description: Close end bulge seat

Quantity: 80/box

Finish: Black Coat

Thread: M14 x 1.5mm

Hex: 7 SPLINE

Overall length: 43.1mm

Seat diameter: 19.4mm

Operating key: 3800L



DUAL HEX SPLINE KEY

3800S

Description: 6 splines

Quantity: 30/box

Finish: Chrome

Hex: 17mm/19mm

Overall length: 73.1mm

Seat diameter: 20.4mm



3800

Description: 6 splines

Quantity: 20/box

Finish: Chrome/Black

Hex: 19mm/21mm

Overall length: 90mm

Seat diameter: 20.4mm



3800LD

Description: 6 splines

Quantity: 20/box

Finish: Chrome/Black

Hex: 21mm/22mm

Overall length: 82mm

Seat diameter: 23.3mm



3800L

Description: 7 splines

Quantity: 20/box

Finish: Chrome/Black

Hex: 21mm/22mm

Overall length: 82mm

Seat diameter: 23mm



TUNER NUT

2807

Description: Inverted hex tuner nut

Quantity: 50/box

Finish: Chrome

Thread: M12 x 1.5mm

Hex: 12mm

Overall length: 32.6mm

Seat diameter: 20mm

Operating key: 2800



DUAL HEX TUNER KEY

2800

Quantity: 30/box

Finish: Chrome

Hex: 19mm/21mm

Key Hex: 12mm

Overall length: 57.9mm



DEM NUTS

5308

Description: Close end bulge seat

Quantity: 30/box

Finish: Chrome

Thread: M14 x 1.5mm

Hex: 22mm

Overall length: 47.6mm

Seat diameter: 26.5mm



5308BK

Description: Close end bulge seat

Quantity: 30/box

Finish: Black coat

Thread: M14 x 1.5mm

Hex: 22mm

Overall length: 47.6mm

Seat diameter: 26.5mm



5330

Description: Close end bulge seat

Quantity: 30/box

Finish: Chrome

Thread: M14 x 1.5mm

Hex: 22mm

Overall length: 38.3mm

Seat diameter: 25mm

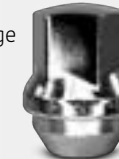

5330BK

Description: Close end bulge seat

Quantity: 30/box

Finish: Black coat

Thread: M14 x 1.5mm

Hex: 22mm

Overall length: 38.3mm

Seat diameter: 25mm

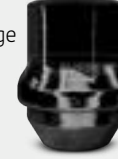

DEM BOLT

1814

Description: 60° Cone seat



Quantity: 50/box

Finish: Chrome

Hex: M12x 1.25mm

Thread: 19mm

Overall length: 58mm

Thread length: 28mm

Seat diameter: 22.4mm

1814BK

Description: 60° Cone seat



Quantity: 50/box

Finish: Black coat

Hex: M12x 1.25mm

Thread: 19mm

Overall length: 58mm

Thread length: 28mm

Seat diameter: 22.4mm



OEM SIZE SPLINE BOLT 6 SPLINE

1843SPC

Description: 60° Cone seat



Quantity: 50/box

Finish: Chrome

Hex: M12x 1.25mm

Thread: 6 spline

Overall length: 54mm

Thread length: 27mm

Seat diameter: 17.6mm

Operating key: 3800S /3800

1843SPBK

Description: 60° Cone seat



Quantity: 50/box

Finish: Black coat

Hex: M12x 1.25mm

Thread: 6 spline

Overall length: 54mm

Thread length: 27mm

Seat diameter: 17.6mm

Operating key: 3800S /3800

OPEN END CONE SEAT

1307

Description: Open end 60° cone seat

Quantity: 100/box

Finish: Chrome

Thread: M12 x 1.5mm

Hex: 19mm

Overall length: 16.1mm



1304

Description: Open end 60° cone seat

Quantity: 100/box

Finish: Chrome

Thread: 1/2"

Hex: 19mm

Overall length: 16.1mm





No cap
One piece
+
TRIPLE
chrome

EPICOR & **Ready Online!**

OPEN END BULGE SEAT

1307-1S

Description: Open end bulge seat
Quantity: 100/box
Finish: Chrome
Thread: M12 x 1.5mm
Hex: 19mm
Overall length: 21.4mm



1312

Description: Open end bulge seat
Quantity: 70/box
Finish: Chrome
Thread: M14 x 1.5mm
Hex: 22mm
Overall length: 21.4mm



1304-1S

Description: Open end bulge seat
Quantity: 100/box
Finish: Chrome
Thread: 1/2"
Hex: 19mm
Overall length: 21.4mm



CLOSE END BULGE SEAT

1907S

Description: Close end bulge seat
Quantity: 50/box
Finish: Chrome
Thread: M12 x 1.5mm
Hex: 19mm
Overall length: 34.7mm
Seat diameter: 22mm



1707BK

Description: Close end bulge seat
Quantity: 50/box
Finish: Black Coat
Thread: M12 x 1.5mm
Hex: 19mm
Overall length: 34.5mm
Seat diameter: 22mm



1904S

Description: Close end bulge seat
Quantity: 50/box
Finish: Chrome
Thread: 1/2"
Hex: 19mm
Overall length: 35.6mm
Seat diameter: 22mm



1904SBK

Description: Close end bulge seat
Quantity: 50/box
Finish: Black Coat
Thread: 1/2"
Hex: 19mm
Overall length: 35.6mm
Seat diameter: 22mm



1909L

Description: Close end bulge seat
Quantity: 40/box
Finish: Chrome
Thread: M14 x 1.5mm
Hex: 21mm
Overall length: 45mm
Seat diameter: 24mm



DUPLEX ACORN

5401

Description: Close end Duplex Acorn
Quantity: 30/box
Finish: Chrome
Thread: M14 x 1.5mm
Hex: 22mm
Overall length: 48.2mm
Seat diameter: 25.5mm



5401BK

Description: Close end Duplex Acorn
Quantity: 30/box
Finish: Black coat
Thread: M14 x 1.5mm
Hex: 22mm
Overall length: 48.2mm
Seat diameter: 25.5mm



5400

Description: Close end Duplex Acorn
Quantity: 30/box
Finish: Chrome
Thread: 1/2"
Hex: 22mm
Overall length: 48.2mm
Seat diameter: 25.5mm



CLOSE END CONE SEAT

1004

Description: Close end 60° cone seat
Quantity: 50/box
Finish: Chrome
Thread: 1/2"
Hex: 21mm
Overall length: 35.3mm



1007

Description: Close end 60° cone seat
Quantity: 50/box
Finish: Chrome
Thread: M12 x 1.5mm
Hex: 21mm
Overall length: 35.3mm



SHORT SHANK DUPLEX ACORN

3009

Description: Close end Duplex Acorn
Quantity: 30/box
Finish: Chrome
Thread: M14 x 1.5mm
Hex: 22mm
Overall length: 46.6mm
Seat diameter: 21.5mm



3004

Description: Close end Duplex Acorn
Quantity: 30/box
Finish: Chrome
Thread: 1/2"
Hex: 22mm
Overall length: 46.6mm
Seat diameter: 21.5mm



OPEN END BULGE SEAT 6 SPLINE

3807-1C

Description: Open end bulge seat
Quantity: 100
Finish: Chrome
Thread: M12 x 1.5mm
Hex: 6 SPLINE
Overall length: 21mm
Seat diameter: 20.2mm
Operating key: 3800/3800s



3804-1C

Description: Open end bulge seat
Quantity: 100
Finish: Chrome
Thread: 1/2"
Hex: 6 SPLINE
Overall length: 21mm
Seat diameter: 20.2mm
Operating key: 3800/3800s



OPEN END BULGE SEAT 7 SPLINE

3809-1DC

Description: Open end bulge seat
Quantity: 80/box
Finish: Chrome
Thread: M14 x 1.5mm
Hex: 7 SPLINE
Overall length: 25.4mm
Seat diameter: 23.3mm
Operating key: 3800L



CLOSE END BULGE SEAT 7 SPLINE

3809-DC

Description: Close end bulge seat
Quantity: 80/box
Finish: Chrome
Thread: M14 x 1.5mm
Hex: 7 SPLINE
Overall length: 43.1mm
Seat diameter: 19.4mm
Operating key: 3800L



TUNER NUT

2807

Description: Inverted hex tuner nut
Quantity: 50/box
Finish: Chrome
Thread: M12 x 1.5mm
Hex: 12mm
Overall length: 32.6mm
Seat diameter: 20mm
Operating key: 2800



2807 BK

Description: Inverted hex tuner nut
Quantity: 50/box
Finish: Black coat
Thread: M12 x 1.5mm
Hex: 12mm
Overall length: 32.6mm
Seat diameter: 20mm
Operating key: 2800



2807 L

Description: Inverted hex tuner nut
Quantity: 25/box
Finish: Chrome
Thread: M14 x 1.5mm
Hex: 15mm
Overall length: 45.4mm
Seat diameter: 20mm
Operating key: 2800L



CLOSE END BULGE SEAT 6 SPLINE

3807-C

Description: Close end bulge seat
Quantity: 80/box
Finish: Chrome
Thread: M12 x 1.5mm
Hex: 6 SPLINE
Overall length: 33.2mm
Seat diameter: 20.2mm
Operating key: 3800/3800s



3807-BK

Description: Close end bulge seat
Quantity: 80/box
Finish: Black coat
Thread: M12 x 1.5mm
Hex: 6 SPLINE
Overall length: 33.2mm
Seat diameter: 21mm
Operating key: 3800/3800s



3804-C

Description: Close end bulge seat
Quantity: 80/box
Finish: Chrome
Thread: 1/2"
Hex: 6 SPLINE
Overall length: 33.2mm
Seat diameter: 20.2mm
Operating key: 3800/3800s



3804-BK

Description: Close end bulge seat
Quantity: 80/box
Finish: Black coat
Thread: 1/2"
Hex: 6 SPLINE
Overall length: 33.2mm
Seat diameter: 21mm
Operating key: 3800/3800s



3804-LC

Description: Close end bulge seat
Quantity: 40/box
Finish: Chrome
Thread: 1/2"
Hex: 6 SPLINE
Overall length: 50.5mm
Seat diameter: 23.1mm
Operating key: 3800LD



3804-LBK

Description: Close end bulge seat
Quantity: 40/box
Finish: Black coat
Thread: 1/2"
Hex: 6 SPLINE
Overall length: 50.5mm
Seat diameter: 23.1mm
Operating key: 3800LD



DUAL HEX SPLINE KEY

3800S

Description: 6 splines
Quantity: 30/box
Finish: Chrome
Hex: 17mm/19mm
Overall length: 73.1mm
Seat diameter: 20.4mm



3800

Description: 6 splines
Quantity: 20/box
Finish: Chrome/Black
Hex: 19mm/21mm
Overall length: 90mm
Seat diameter: 20.4mm



3800LD

Description: 6 splines
Quantity: 20/box
Finish: Chrome/Black
Hex: 21mm/22mm
Overall length: 82mm
Seat diameter: 23.3mm



3800L

Description: 7 splines
Quantity: 20/box
Finish: Chrome/Black
Hex: 21mm/22mm
Overall length: 82mm
Seat diameter: 23mm



DUAL HEX TUNER KEY

2800

Quantity: 30/box
Finish: Chrome
Hex: 19mm/21mm
Key Hex: 12mm
Overall length: 57.9mm



2800L

Quantity: 30/box
Finish: Chrome
Hex: 19mm/21mm
Key Hex: 14.7mm
Overall length: 63.5mm



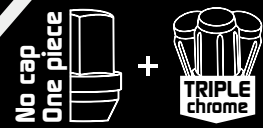

OEM NUTS

5303M

Description: Close end 60° cone seat
Quantity: 80/box
Finish: Chrome
Thread: M12 x 1.5mm
Hex: 21mm
Overall length: 25.8mm
Seat diameter: 23.2mm



5303MBK

Description: Close end 60° cone seat
Quantity: 0/box
Finish: Black coat
Thread: M12 x 1.5mm
Hex: 21mm
Overall length: 25.8mm
Seat diameter: 23.2mm



I 33

Description: Close end 60° cone seat
Quantity: 50/box
Finish: Chrome
Thread: M12 x 1.5mm
Hex: 21mm
Overall length: 30mm



I 707H

Description: Close end bulge seat
Quantity: 40/box
Finish: Chrome
Thread: M12 x 1.5mm
Hex: 19mm
Overall length: 31.3mm
Seat diameter: 24.2mm



5307BK

Description: Close end shank seat with washer
Quantity: 40/box
Finish: Black coat
Thread: M12 x 1.5mm
Hex: 21mm
Overall length: 37mm
Seat diameter: 18.3mm
Washer diameter: 30mm



5307

Description: Close end shank seat with washer
Quantity: 40/box
Finish: Chrome
Thread: M12 x 1.5mm
Hex: 21mm
Overall length: 37mm
Seat diameter: 18.3mm
Washer diameter: 30mm



OEM COVER RETAINING NUT

209

Description: Close end cover retaining with plastic washer
Quantity: 50/box
Finish: Chrome
Thread: M12 x 1.5mm
Hex: 21mm
Overall length: 33mm
Seat diameter: 23.7mm
Seat diameter: 27.7mm



I 707CP

Description: Close end bulge seat with plastic washer
Quantity: 40/box
Finish: Chrome
Thread: M12 x 1.5mm
Hex: 21mm
Overall length: 33mm
Seat diameter: 23.7mm
Seat diameter: 27.7mm



OPEN END CONE SEAT

I 327

Description: Open end 60° cone seat
Quantity: 100/box
Finish: Chrome
Thread: M12 x 1.5mm
Hex: 21mm
Overall length: 16mm



OPEN END BULGE SEAT

I 307-1

Description: Open end bulge seat
Quantity: 100/box
Finish: Chrome
Thread: M12 x 1.5mm
Hex: 21mm
Overall length: 21mm



CLOSE END CONE SEAT

I 007

Description: Close end 60° cone seat
Quantity: 50/box
Finish: Chrome
Thread: M12 x 1.5mm
Hex: 21mm
Overall length: 35.3mm



CLOSE END BULGE SEAT

I 907

Description: Close end bulge seat
Quantity: 50/box
Finish: Chrome
Thread: M12 x 1.5mm
Hex: 21mm
Overall length: 34.7mm
Seat diameter: 24mm



I 907BK

Description: Close end bulge seat
Quantity: 50/box
Finish: Black coat
Thread: M12 x 1.5mm
Hex: 21mm
Overall length: 34.7mm
Seat diameter: 24mm



OPEN END BULGE SEAT 6 SPLINE

3807-1C

Description: Open end bulge seat
Quantity: 100
Finish: Chrome
Thread: M12 x 1.5mm
Hex: 6 SPLINE
Overall length: 21mm
Seat diameter: 20.2mm
Operating key: 3800/3800s



CLOSE END BULGE SEAT 6 SPLINE

3807-C

Description: Close end bulge seat
Quantity: 80/box
Finish: Chrome
Thread: M12 x 1.5mm
Hex: 6 SPLINE
Overall length: 33.2mm
Seat diameter: 20.2mm
Operating key: 3800/3800s



3807-BK

Description: Close end bulge seat
Quantity: 80/box
Finish: Black coat
Thread: M12 x 1.5mm
Hex: 6 SPLINE
Overall length: 33.2mm
Seat diameter: 21mm
Operating key: 3800/3800s



TUNER NUT

2807

Description: Inverted hex tuner nut
Quantity: 50/box
Finish: Chrome
Thread: M12 x 1.5mm
Hex: 12mm
Overall length: 32.6mm
Seat diameter: 20mm
Operating key: 2800



2807 BK

Description: Inverted hex tuner nut
Quantity: 50/box
Finish: Black coat
Thread: M12 x 1.5mm
Hex: 12mm
Overall length: 32.6mm
Seat diameter: 20mm
Operating key: 2800



DUAL HEX SPLINE KEY

3800S

Description: 6 splines
Quantity: 30/box
Finish: Chrome
Hex: 17mm/19mm
Overall length: 73.1mm
Seat diameter: 20.4mm



3800

Description: 6 splines
Quantity: 20/box
Finish: Chrome/Black
Hex: 19mm/21mm
Overall length: 90mm
Seat diameter: 20.4mm



DUAL HEX TUNER KEY

2800

Description:
Quantity: 30/box
Finish: Chrome
Hex: 19mm/21mm
Key Hex: 12mm
Overall length: 57.9mm



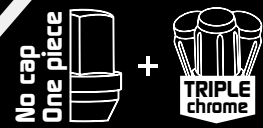

DEM NUTS

200 IS

Description: Close end variable 60° cone seat nut
Quantity: 40/box
Finish: Chrome
Thread: M14 x 1.5mm
Hex: 21mm
Overall length: 35mm
Seat Diameter: 28mm



200 IL

Description: Close end shank seat with washer
Quantity: 25/box
Finish: Chrome
Thread: M14 x 1.5mm
Hex: 22mm
Overall length: 42.7mm
Seat Diameter: 22.2mm
Washer Diameter: 33.6mm



200 ILBK

Description: Close end shank seat with washer
Quantity: 25/box
Finish: Black coat
Thread: M14 x 1.5mm
Hex: 22mm
Overall length: 42.7mm
Seat Diameter: 22.2mm
Washer Diameter: 33.6mm



OPEN END BALL SEAT

I307-1R

Description: Open end R12 ball seat
Quantity: 80/box
Finish: Chrome
Thread: M12 x 1.5mm
Hex: 19mm
Overall length: 21mm



CLOSE END BALL SEAT

I907HR

Description: Close end ball seat R12
Quantity: 40/box
Finish: Chrome
Thread: M12 x 1.5mm
Hex: 19mm
Overall length: 35mm
Seat diameter: 22mm



OPEN END BULGE SEAT

I312

Description: Open end bulge seat
Quantity: 70/box
Finish: Chrome
Thread: M14 x 1.5mm
Hex: 22mm
Overall length: 21.4mm



CLOSE END BULGE SEAT

I909L

Description: Close end bulge seat
Quantity: 40/box
Finish: Chrome
Thread: M14 x 1.5mm
Hex: 21mm
Overall length: 45mm
Seat diameter: 24mm



DUPLEX ACORN

540 I

Description: Close end Duplex Acorn
Quantity: 30/box
Finish: Chrome
Thread: M14 x 1.5mm
Hex: 22mm
Overall length: 48.2mm
Seat diameter: 25.5mm



540 IBK

Description: Close end Duplex Acorn
Quantity: 30/box
Finish: Black coat
Thread: M14 x 1.5mm
Hex: 22mm
Overall length: 48.2mm
Seat diameter: 25.5mm



OPEN END BULGE SEAT 7 SPLINE

3809-1DC

Description: Open end bulge seat
Quantity: 80/box
Finish: Chrome
Thread: M14 x 1.5mm
Hex: 25.4mm
Overall length: 25.4mm
Seat diameter: 23.3mm
Operating key: 3800L



CLOSE END BULGE SEAT 7 SPLINE

3809-DC

Description: Close end bulge seat
Quantity: 80/box
Finish: Chrome
Thread: M14 x 1.5mm
Hex: 25.4mm
Overall length: 43.1mm
Seat diameter: 19.4mm
Operating key: 3800L



3809-DBK

Description: Close end bulge seat
Quantity: 80/box
Finish: Black Coat
Thread: M14 x 1.5mm
Hex: 25.4mm
Overall length: 43.1mm
Seat diameter: 19.4mm
Operating key: 3800L



SHORT SHANK DUPLEX ACORN

3009

Description: Close end Duplex Acorn
Quantity: 30/box
Finish: Chrome
Thread: M14 x 1.5mm
Hex: 22mm
Overall length: 46.6mm
Seat diameter: 21.5mm



DUAL HEX SPLINE KEY

3800L

Description: 7 splines
Quantity: 20/box
Finish: Chrome/Black
Hex: 21mm/22mm
Overall length: 82mm
Seat diameter: 23mm



3 Times Chromed
Times The Satisfaction

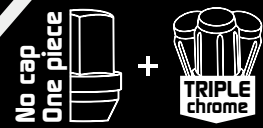

OEM Wheel Seat Application

OEM NUTS

5307

Description:
Close end shank seat with washer

Quantity: 40/box
Finish: Chrome
Thread: M12 x 1.5mm
Hex: 21mm
Overall length: 37mm
Seat diameter: 18.3mm
Washer diameter: 30mm



5307BK

Description:
Close end shank seat with washer

Quantity: 40/box
Finish: Black coat
Thread: M12 x 1.5mm
Hex: 21mm
Overall length: 37mm
Seat diameter: 18.3mm
Washer diameter: 30mm



5301M

Description:
Close end shank seat with washer

Quantity: 40/box
Finish: Chrome
Thread: M12 x 1.5mm
Hex: 21mm
Overall length: 36.8mm
Seat diameter: 18.3mm
Washer diameter: 30mm



5307XL

Description:
Close end shank seat with washer

Quantity: 30/box
Finish: Chrome
Thread: M12 x 1.5mm
Hex: 21mm
Overall length: 46mm
Seat diameter: 18.3mm
Washer diameter: 30mm



5309S

Description:
Close end shank seat with washer

Quantity: 35/box
Finish: Chrome
Thread: M14 x 1.5mm
Hex: 21mm
Overall length: 48.4mm
Seat diameter: 18.3mm
Washer diameter: 29.8mm



5309

Description:
Close end shank seat with washer

Quantity: 25/box
Finish: Chrome
Thread: M14 x 1.5mm
Hex: 22mm
Overall length: 48.4mm
Seat diameter: 20.8mm
Washer diameter: 34mm



Aftermarket Wheel Seat Application

OPEN END CONE SEAT

1327

Description:
Open end 60° cone seat

Quantity: 100/box
Finish: Chrome
Thread: M12 x 1.5mm
Hex: 21mm
Overall length: 16mm



OPEN END BULGE SEAT

1307-1

Description:
Open end bulge seat

Quantity: 80/box
Finish: Chrome
Thread: M12 x 1.5mm
Hex: 21mm
Overall length: 21mm



1309-1

Description:
Open end bulge seat

Quantity: 80/box
Finish: Chrome
Thread: M14x 1.5mm
Hex: 21mm
Overall length: 21mm



1312

Description:
Open end bulge seat

Quantity: 70/box
Finish: Chrome
Thread: M14 x 1.5mm
Hex: 22mm
Overall length: 21.4mm



CLOSE END CONE SEAT

1007

Description:
Close end 60° cone seat

Quantity: 50/box
Finish: Chrome
Thread: M12 x 1.5mm
Hex: 21mm
Overall length: 35.3mm



CLOSE END BULGE SEAT

1907SL

Description:
Close end bulge seat

Quantity: 40/box
Finish: Chrome
Thread: M12 x 1.5mm
Hex: 19mm
Overall length: 50mm
Seat diameter: 23mm



1909L

Description:
Close end bulge seat

Quantity: 40/box
Finish: Chrome
Thread: M14 x 1.5mm
Hex: 21mm
Overall length: 45mm
Seat diameter: 24mm



DUPLEX ACORN

5401

Description:
Close end Duplex Acorn

Quantity: 30/box
Finish: Chrome
Thread: M14 x 1.5mm
Hex: 22mm
Overall length: 48.2mm
Seat diameter: 25.5mm



5401BK

Description:
Close end Duplex Acorn

Quantity: 30/box
Finish: Black coat
Thread: M14 x 1.5mm
Hex: 22mm
Overall length: 48.2mm
Seat diameter: 25.5mm



SHORT SHANK DUPLEX ACORN

3009

Description:
Close end Duplex Acorn

Quantity: 30/box
Finish: Chrome
Thread: M14 x 1.5mm
Hex: 22mm
Overall length: 46.6mm
Seat diameter: 21.5mm



OPEN END BULGE SEAT 6 SPLINE

3807-1C

Description:
Open end bulge seat

Quantity: 100
Finish: Chrome
Thread: M12 x 1.5mm
Hex: 6 SPLINE
Overall length: 21mm
Seat diameter: 20.2mm
Operating key: 3800/3800s



CLOSE END BULGE SEAT 6 SPLINE

3807-C

Description:
Close end bulge seat

Quantity: 80/box
Finish: Chrome
Thread: M12 x 1.5mm
Hex: 6 SPLINE
Overall length: 33.2mm
Seat diameter: 20.2mm
Operating key: 3800/3800s



3807-BK

Description:
Close end bulge seat

Quantity: 80/box
Finish: Black coat
Thread: M12 x 1.5mm
Hex: 6 SPLINE
Overall length: 33.2mm
Seat diameter: 21mm
Operating key: 3800/3800s



OPEN END BULGE SEAT 7 SPLINE

3809-1DC

Description:
Open end bulge seat

Quantity: 80/box
Finish: Chrome
Thread: M14 x 1.5mm
Hex: 7 SPLINE
Overall length: 25.4mm
Seat diameter: 23.3mm
Operating key: 3800L



CLOSE END BULGE SEAT 7 SPLINE

3809-DLC

Description:
Close end bulge seat

Quantity: 40/box
Finish: Chrome
Thread: M14 x 1.5mm
Hex: 7 SPLINE
Overall length: 51.7mm
Seat diameter: 23mm
Operating key: 3800L



3809-DLBK

Description:
Close end bulge seat

Quantity: 40/box
Finish: Black Coat
Thread: M14 x 1.5mm
Hex: 7 SPLINE
Overall length: 51.7mm
Seat diameter: 23mm
Operating key: 3800L



DUAL HEX SPLINE KEY

3800S

Description:
6 splines

Quantity: 30/box
Finish: Chrome
Hex: 17mm/19mm
Overall length: 73.1mm
Seat diameter: 20.4mm



3800

Description:
6 splines

Quantity: 20/box
Finish: Chrome/Black
Hex: 19mm/21mm
Overall length: 90mm
Seat diameter: 20.4mm



3800L

Description:
7 splines

Quantity: 20/box
Finish: Chrome/Black
Hex: 21mm/22mm
Overall length: 82mm
Seat diameter: 23mm



3800LD

Description:
6 splines

Quantity: 20/box
Finish: Chrome/Black
Hex: 21mm/22mm
Overall length: 82mm
Seat diameter: 23.3mm



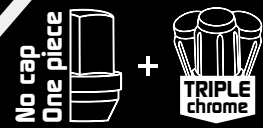

DEM NUTS

<p>303 Description: Close end bulge seat Quantity: 50/box Finish: Chrome Thread: M12 x 1.5mm Hex: 19mm Overall length: 32mm Seat diameter: 22mm</p> 	<p>303BK Description: Close end bulge seat Quantity: 50/box Finish: Black coat Thread: M12 x 1.5mm Hex: 19mm Overall length: 32mm Seat diameter: 22mm</p> 	<p>288 Description: Close end bulge seat Quantity: 25/box Finish: Chrome Thread: M14 x 2.0mm Hex: 21mm Overall length: 54.6mm Seat diameter: 28.4mm</p> 	<p>288BK Description: Close end bulge seat Quantity: 25/box Finish: Black coat Thread: M14 x 2.0mm Hex: 21mm Overall length: 54.6mm Seat diameter: 28.4mm</p> 
<p>289 Description: Close end bulge seat Quantity: 25/box Finish: Chrome Thread: M14 x 1.5mm Hex: 21mm Overall length: 41.8mm Seat diameter: 26.9mm</p> 	<p>289BK Description: Close end bulge seat Quantity: 25/box Finish: Black coat Thread: M14 x 1.5mm Hex: 21mm Overall length: 41.8mm Seat diameter: 26.9mm</p> 	<p>290 Description: Close end bulge seat Quantity: 25/box Finish: Chrome Thread: M14 x 2.0mm Hex: 21mm Overall length: 62.4mm Seat diameter: 28.4mm</p> 	

DEM FLAT FLANGE

2004F
Description: Open end variable flat faced flange
Quantity: 50/box
Finish: Black coat
Thread: M14 x 2.0mm
Hex: 21mm
Overall length: 22mm
Flange diameter: 7.5mm



DEM COVER RETAINING NUT

2005F
Description: Open end bulge seat
Quantity: 35/box
Finish: Chrome
Thread: M14 x 2.0mm
Hex: 21mm
Overall length: 30.8mm
Seat diameter: 26.7mm



OPEN END CONE SEAT

<p>1307 Description: Open end 60° cone seat Quantity: 100/box Finish: Chrome Thread: M12 x 1.5mm Hex: 19mm Overall length: 16.1mm</p> 	<p>1304 Description: Open end 60° cone seat Quantity: 100/box Finish: Chrome Thread: 1/2" Hex: 19mm Overall length: 16.1mm</p> 
--	---

CLOSE END CONE SEAT

<p>1004 Description: Close end 60° cone seat Quantity: 50/box Finish: Chrome Thread: 1/2" Hex: 21mm Overall length: 35.3mm</p> 	<p>1007 Description: Close end 60° cone seat Quantity: 50/box Finish: Chrome Thread: M12 x 1.5mm Hex: 21mm Overall length: 35.3mm</p> 
--	--

OPEN END BULGE SEAT

<p>I309-I Description: Open end bulge seat Quantity: 80/box Finish: Chrome Thread: M14x 1.5mm Hex: 21mm Overall length: 21mm</p> 	<p>I309-IS Description: Open end bulge seat Quantity: 100/box Finish: Chrome Thread: M14 x 1.5mm Hex: 19mm Overall length: 21.4mm</p> 	<p>I304-IS Description: Open end bulge seat Quantity: 100/box Finish: Chrome Thread: 1/2" Hex: 19mm Overall length: 21.4mm</p> 	<p>I350-I Description: Open end bulge seat Quantity: 80/box Finish: Chrome Thread: M14x2.0mm Hex: 21mm Overall length: 21mm</p> 
---	--	---	--

CLOSE END BULGE SEAT

<p>I907S Description: Close end bulge seat Quantity: 50/box Finish: Chrome Thread: M12 x 1.5mm Hex: 19mm Overall length: 34.7mm Seat diameter: 22mm</p> 	<p>I707BK Description: Close end bulge seat Quantity: 50/box Finish: Black Coat Thread: M12 x 1.5mm Hex: 19mm Overall length: 34.5mm Seat diameter: 22mm</p> 	<p>I909L Description: Close end bulge seat Quantity: 40/box Finish: Chrome Thread: M14 x 1.5mm Hex: 21mm Overall length: 45mm Seat diameter: 24mm</p> 	<p>I904SL Description: Close end bulge seat Quantity: 40/box Finish: Chrome Thread: 1/2" Hex: 19mm Overall length: 50mm Seat diameter: 23mm</p> 
<p>I950L Description: Close end bulge seat Quantity: 40/box Finish: Chrome Thread: M14 x 2.0mm Hex: 21mm Overall length: 45mm Seat diameter: 24mm</p> 	<p>I907SL Description: Close end bulge seat Quantity: 40/box Finish: Chrome Thread: M12 x 1.5mm Hex: 19mm Overall length: 50mm Seat diameter: 23mm</p> 		

DUPLEX ACORN

<p>540 I Description: Close end Duplex Acorn Quantity: 30/box Finish: Chrome Thread: M14 x 1.5mm Hex: 22mm Overall length: 48.2mm Seat diameter: 25.5mm</p> 	<p>540 I BK Description: Close end Duplex Acorn Quantity: 30/box Finish: Black coat Thread: M14 x 1.5mm Hex: 22mm Overall length: 48.2mm Seat diameter: 25.5mm</p> 	<p>5403 Description: Close end Duplex Acorn Quantity: 30/box Finish: Chrome Thread: M14 x 2.0mm Hex: 22mm Overall length: 48.2mm Seat diameter: 25.5mm</p> 	<p>5400 Description: Close end Duplex Acorn Quantity: 30/box Finish: Chrome Thread: 1/2" Hex: 22mm Overall length: 48.2mm Seat diameter: 25.5mm</p> 
--	---	---	--

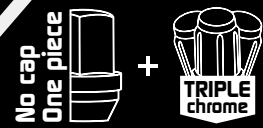

SHORT SHANK DUPLEX ACORN

<p>3009 Description: Close end Duplex Acorn Quantity: 30/box Finish: Chrome Thread: M14 x 1.5mm Hex: 22mm Overall length: 46.6mm Seat diameter: 21.5mm</p> 	<p>3050 Description: Close end Duplex Acorn Quantity: 30/box Finish: Chrome Thread: M14 x 2.0mm Hex: 22mm Overall length: 46.6mm Seat diameter: 21.5mm</p> 	<p>3004 Description: Close end Duplex Acorn Quantity: 30/box Finish: Chrome Thread: 1/2" Hex: 22mm Overall length: 46.6mm Seat diameter: 21.5mm</p> 
---	---	---

CLOSE END BULGE SEAT 6 SPLINE

<p>3807-C Description: Close end bulge seat Quantity: 80/box Finish: Chrome Thread: M12 x 1.5mm Hex: 12mm Overall length: 33.2mm Seat diameter: 20.2mm Operating key: 3800/3800s</p> 	<p>3807-BK Description: Close end bulge seat Quantity: 80/box Finish: Black coat Thread: M12 x 1.5mm Hex: 12mm Overall length: 33.2mm Seat diameter: 21mm Operating key: 3800/3800s</p> 
---	--

OPEN END BULGE SEAT 6 SPLINE

<p>3807-IC Description: Open end bulge seat Quantity: 100 Finish: Chrome Thread: M12 x 1.5mm Hex: 12mm Overall length: 21mm Seat diameter: 20.2mm Operating key: 3800/3800s</p> 	<p>3804-IC Description: Open end bulge seat Quantity: 100 Finish: Chrome Thread: 1/2" Hex: 6 SPLINE Overall length: 21mm Seat diameter: 20.2mm Operating key: 3800/3800s</p> 
---	---

<p>3804-LC Description: Close end bulge seat Quantity: 40/box Finish: Chrome Thread: 1/2" Hex: 6 SPLINE Overall length: 50.5mm Seat diameter: 23.1mm Operating key: 3800LD</p> 	<p>3804-LBK Description: Close end bulge seat Quantity: 40/box Finish: Black coat Thread: 1/2" Hex: 6 SPLINE Overall length: 50.5mm Seat diameter: 23.1mm Operating key: 3800LD</p> 
---	--

<p>3807-LC Description: Close end bulge seat Quantity: 40/box Finish: Chrome Thread: M12 x 1.5mm Hex: 12mm Overall length: 50.5mm Seat diameter: 23.1mm Operating key: 3800LD</p> 	<p>3807-LBK Description: Close end bulge seat Quantity: 40/box Finish: Black coat Thread: M12 x 1.5mm Hex: 12mm Overall length: 50.5mm Seat diameter: 23.1mm Operating key: 3800LD</p> 
---	---

OPEN END BULGE SEAT 7 SPLINE

<p>3809-IDC Description: Open end bulge seat Quantity: 80/box Finish: Chrome Thread: M14 x 1.5mm Hex: 7 SPLINE Overall length: 25.4mm Seat diameter: 23.3mm Operating key: 3800L</p> 	<p>3850-IDC Description: Open end bulge seat Quantity: 80/box Finish: Chrome Thread: M14 x 2.0mm Hex: 7 SPLINE Overall length: 25.4mm Seat diameter: 23.3mm Operating key: 3800L</p> 
---	---

CLOSE END BULGE SEAT 7 SPLINE

<p>3809-DC Description: Close end bulge seat Quantity: 80/box Finish: Chrome Thread: M14 x 1.5mm Hex: 7 SPLINE Overall length: 43.1mm Seat diameter: 19.4mm Operating key: 3800L</p> 	<p>3809-DBK Description: Close end bulge seat Quantity: 80/box Finish: Black Coat Thread: M14 x 1.5mm Hex: 7 SPLINE Overall length: 43.1mm Seat diameter: 19.4mm Operating key: 3800L</p> 
--	--

CLOSE END BULGE SEAT 7 SPLINE

<p>3850-DLC Description: Close end bulge seat Quantity: 40/box Finish: Chrome Thread: M14 x 2.0mm Hex: 7 SPLINE Overall length: 51.7mm Seat diameter: 23mm Operating key: 3800L</p> 	<p>3850-DLBK Description: Close end bulge seat Quantity: 40/box Finish: Black coat Thread: M14 x 2.0mm Hex: 7 SPLINE Overall length: 51.7mm Seat diameter: 23mm Operating key: 3800L</p> 	<p>3809-DLC Description: Close end bulge seat Quantity: 40/box Finish: Chrome Thread: M14 x 1.5mm Hex: 7 SPLINE Overall length: 51.7mm Seat diameter: 23mm Operating key: 3800L</p> 	<p>3809-DLBK Description: Close end bulge seat Quantity: 40/box Finish: Black Coat Thread: M14 x 1.5mm Hex: 7 SPLINE Overall length: 51.7mm Seat diameter: 23mm Operating key: 3800L</p> 
--	---	--	---



TUNER NUT

<p>2807 Description: Inverted hex tuner nut Quantity: 50/box Finish: Chrome Thread: M12 x 1.5mm Hex: 12mm Overall length: 32.6mm Seat diameter: 20mm Operating key: 2800</p> 	<p>2807BK Description: Inverted hex tuner nut Quantity: 50/box Finish: Black coat Thread: M12 x 1.5mm Hex: 12mm Overall length: 32.6mm Seat diameter: 20mm Operating key: 2800</p> 	<p>2807L Description: Inverted hex tuner nut Quantity: 25/box Finish: Chrome Thread: M14 x 1.5mm Hex: 15mm Overall length: 45.4mm Seat diameter: 20mm Operating key: 2800L</p> 
---	---	---

DUAL HEX SPLINE KEY

<p>3800S Description: 6 splines Quantity: 30/box Finish: Chrome Hex: 17mm/19mm Overall length: 73.1mm Seat diameter: 20.4mm</p> 	<p>3800 Description: 6 splines Quantity: 20/box Finish: Chrome/Black Hex: 19mm/21mm Overall length: 90mm Seat diameter: 20.4mm</p> 	<p>3800L Description: 7 splines Quantity: 20/box Finish: Chrome/Black Hex: 21mm/22mm Overall length: 82mm Seat diameter: 23mm</p> 	<p>3800LD Description: 6 splines Quantity: 20/box Finish: Chrome/Black Hex: 21mm/22mm Overall length: 82mm Seat diameter: 23.3mm</p> 
--	---	--	---

DUAL HEX TUNER KEY

<p>2800 Quantity: 30/box Finish: Chrome Hex: 19mm/21mm Key Hex: 12mm Overall length: 57.9mm</p> 	<p>2800L Quantity: 30/box Finish: Chrome Hex: 19mm/21mm Key Hex: 14.7mm Overall length: 63.5mm</p> 
--	---

No cap One piece



All Nuts

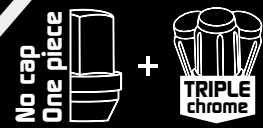

EPICOR & **TWH**
Ready Online!

CLOSE END BALL SEAT

1907HR

Description: Close end ball seat R12
Quantity: 40/box
Finish: Chrome
Thread: M12 x 1.5mm
Hex: 19mm
Overall length: 35mm
Seat diameter: 22mm



3 Times Chromed
Times The Satisfaction

DEM BOLT

1807

Description: 60° Cone seat
Quantity: 50/box
Finish: Chrome
Hex: M12 x 1.5 mm
Thread: 17mm
Overall length: 56mm
Thread length: 28mm
Seat diameter: 22mm



1807BK

Description: 60° Cone seat
Quantity: 50/box
Finish: Black coat
Hex: M12 x 1.5 mm
Thread: 17mm
Overall length: 56mm
Thread length: 28mm
Seat diameter: 22mm



1806

Description: 60° Cone seat
Quantity: 50/box
Finish: Chrome
Hex: M12 x 1.5 mm
Thread: 17mm
Overall length: 52.2mm
Thread length: 24mm
Seat diameter: 22.7mm



1806BK

Description: 60° Cone seat
Quantity: 50/box
Finish: Black coat
Hex: M12 x 1.5 mm
Thread: 17mm
Overall length: 52.2mm
Thread length: 24mm
Seat diameter: 22.7mm



DEM SIZE BOLT

1807SPC

Description: 60° Cone seat
Quantity: 50/box
Finish: Chrome
Hex: M12 x 1.5 mm
Thread: 6 SPLINE
Overall length: 55.7mm
Thread length: 28mm
Seat diameter: 20mm
Operating Key: 3800/3800s



1807SPBK

Description: 60° Cone seat
Quantity: 50/box
Finish: Black coat
Hex: M12 x 1.5 mm
Thread: 6 SPLINE
Overall length: 55.7mm
Thread length: 28mm
Seat diameter: 20mm
Operating Key: 3800/3800s



DUAL HEX SPLINE KEY

3800S

Description: 6 splines
Quantity: 30/box
Finish: Chrome
Hex: 17mm/19mm
Overall length: 73.1mm
Seat diameter: 20.4mm



3800

Description: 6 splines
Quantity: 20/box
Finish: Chrome/Black
Hex: 19mm/21mm
Overall length: 90mm
Seat diameter: 20.4mm



DEM NUTS

5303M

Description: Close end 60° cone seat
Quantity: 80/box
Finish: Chrome
Thread: M12 x 1.5mm
Hex: 21mm
Overall length: 25.8mm
Seat diameter: 23.2mm



5303MBK

Description: Close end 60° cone seat
Quantity: 0/box
Finish: Black coat
Thread: M12 x 1.5mm
Hex: 21mm
Overall length: 25.8mm
Seat diameter: 23.2mm



DEM COVER RETAINING NUT

199

Description: Open end short shank seat
Quantity: 40/box
Finish: Zink plated
Thread: 1/2"
Hex: 19mm
Overall length: 31.4 mm
Seat diameter: 21.5mm
Flange diameter: 28.3mm



OPEN END CONE SEAT

1307

Description: Open end 60° cone seat
Quantity: 100/box
Finish: Chrome
Thread: M12 x 1.5mm
Hex: 19mm
Overall length: 16.1mm



1324

Description: Open end 60° cone seat
Quantity: 100/box
Finish: Chrome
Thread: 1/2"
Hex: 21mm
Overall length: 16mm



1327

Description: Open end 60° cone seat
Quantity: 100/box
Finish: Chrome
Thread: M12 x 1.5mm
Hex: 21mm
Overall length: 16mm



OPEN END BULGE SEAT

1307-1S

Description: Open end bulge seat
Quantity: 100/box
Finish: Chrome
Thread: M12 x 1.5mm
Hex: 19mm
Overall length: 21.4mm



1307-1

Description: Open end bulge seat
Quantity: 80/box
Finish: Chrome
Thread: M12 x 1.5mm
Hex: 21mm
Overall length: 21mm



1304-1

Description: Open end bulge seat
Quantity: 80/box
Finish: Chrome
Thread: 1/2"
Hex: 21mm
Overall length: 21mm



LOTUS

MAZDA

MAZDA

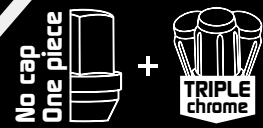

CLOSE END CONE SEAT

1004

Description: Close end 60° cone seat

Quantity: 50/box

Finish: Chrome

Thread: 1/2"

Hex: 21mm

Overall length: 35.3mm



1007

Description: Close end 60° cone seat

Quantity: 50/box

Finish: Chrome

Thread: M12 x 1.5mm

Hex: 21mm

Overall length: 35.3mm



CLOSE END BULGE SEAT

1907

Description: Close end bulge seat

Quantity: 50/box

Finish: Chrome

Thread: M12 x 1.5mm

Hex: 21mm

Overall length: 34.7mm

Seat diameter: 24mm



1907BK

Description: Close end bulge seat

Quantity: 50/box

Finish: Black coat

Thread: M12 x 1.5mm

Hex: 21mm

Overall length: 34.7mm

Seat diameter: 24mm



1904SL

Description: Close end bulge seat

Quantity: 40/box

Finish: Chrome

Thread: 1/2"

Hex: 19mm

Overall length: 50mm

Seat diameter: 23mm



1907SL

Description: Close end bulge seat

Quantity: 40/box

Finish: Chrome

Thread: M12 x 1.5mm

Hex: 19mm

Overall length: 50mm

Seat diameter: 23mm



DUPLEX ACORN

5400

Description: Close end Duplex Acorn

Quantity: 30/box

Finish: Chrome

Thread: 1/2"

Hex: 22mm

Overall length: 48.2mm

Seat diameter: 25.5mm



SHORT SHANK DUPLEX ACORN

3009

Description: Close end Duplex Acorn

Quantity: 30/box

Finish: Chrome

Thread: M14 x 1.5mm

Hex: 22mm

Overall length: 46.6mm

Seat diameter: 21.5mm



CLOSE END BULGE SEAT 6 SPLINE

3807-C

Description: Close end bulge seat

Quantity: 80/box

Finish: Chrome

Thread: M12 x 1.5mm

Hex: 6 SPLINE

Overall length: 33.2mm

Seat diameter: 20.2mm

Operating key: 3800/3800s



3807-BK

Description: Close end bulge seat

Quantity: 80/box

Finish: Black coat

Thread: M12 x 1.5mm

Hex: 6 SPLINE

Overall length: 33.2mm

Seat diameter: 21mm

Operating key: 3800/3800s



3804-LC

Description: Close end bulge seat

Quantity: 40/box

Finish: Chrome

Thread: 1/2"

Hex: 6 SPLINE

Overall length: 50.5mm

Seat diameter: 23.1mm

Operating key: 3800LD



3804-LBK

Description: Close end bulge seat

Quantity: 40/box

Finish: Black coat

Thread: 1/2"

Hex: 6 SPLINE

Overall length: 50.5mm

Seat diameter: 23.1mm

Operating key: 3800LD



OPEN END BULGE SEAT 6 SPLINE

3807-1C

Description: Open end bulge seat

Quantity: 100

Finish: Chrome

Thread: M12 x 1.5mm

Hex: 6 SPLINE

Overall length: 21mm

Seat diameter: 20.2mm

Operating key: 3800/3800s



3804-1C

Description: Open end bulge seat

Quantity: 100

Finish: Chrome

Thread: 1/2"

Hex: 6 SPLINE

Overall length: 21mm

Seat diameter: 20.2mm

Operating key: 3800/3800s



TUNER NUT

2807

Description: Inverted hex tuner nut

Quantity: 50/box

Finish: Chrome

Thread: M12 x 1.5mm

Hex: 12mm

Overall length: 32.6mm

Seat diameter: 20mm

Operating key: 2800



2807BK

Description: Inverted hex tuner nut

Quantity: 50/box

Finish: Black coat

Thread: M12 x 1.5mm

Hex: 12mm

Overall length: 32.6mm

Seat diameter: 20mm

Operating key: 2800



DUAL HEX SPLINE KEY

3800S

Description: 6 splines

Quantity: 30/box

Finish: Chrome

Hex: 17mm/19mm

Overall length: 73.1mm

Seat diameter: 20.4mm



3800

Description: 6 splines

Quantity: 20/box

Finish: Chrome/Black

Hex: 19mm/21mm

Overall length: 90mm

Seat diameter: 20.4mm



3800LD

Description: 6 splines

Quantity: 20/box

Finish: Chrome/Black

Hex: 21mm/22mm

Overall length: 82mm

Seat diameter: 23.3mm



DUAL HEX TUNER KEY

2800

Quantity: 30/box

Finish: Chrome

Hex: 19mm/21mm

Key Hex: 12mm

Overall length: 57.9mm



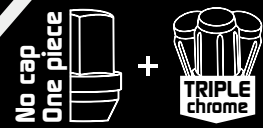

DEM Wheel Seat Application

DEM BOLT

1809S

Description:
R13 Ball seat



Quantity: 50/box
Finish: Chrome
Thread: M14 x 1.5mm
Hex: 17mm
Overall length: 48.5mm
Thread length: 24mm
Seat diameter: 23mm

1809SBK

Description:
R13 Ball seat



Quantity: 50/box
Finish: Black coat
Thread: M14 x 1.5mm
Hex: 17mm
Overall length: 48.5mm
Thread length: 24mm
Seat diameter: 23mm

1809LSS

Description:
R13 Ball seat



Quantity: 35/box
Finish: Chrome
Thread: M14 x 1.5mm
Hex: 17mm
Overall length: 70mm
Thread length: 45mm
Seat diameter: 23mm

1809LSSBK

Description:
R13 Ball seat



Quantity: 35/box
Finish: Black coat
Thread: M14 x 1.5mm
Hex: 17mm
Overall length: 70mm
Thread length: 45mm
Seat diameter: 23mm

1808L

Description:
R13 ball seat



Quantity: 40/box
Finish: Chrome
Hex: M12 x 1.5mm
Thread: 17mm
Overall length: 64.7mm
Thread length: 39mm
Seat diameter: 22mm

1808SM

Description:
R13 ball seat



Quantity: 50/box
Finish: Dacromet coat
Hex: M12 x 1.5mm
Thread: 17mm
Overall length: 39mm
Thread length: 19mm
Seat diameter: 22.7mm

1809MS

Description:
R14 ball seat



Quantity: 30/box
Finish: Dacromet coat
Hex: M14 x 1.5mm
Thread: 19mm
Overall length: 58.3mm
Thread length: 30mm
Seat diameter: 25.5mm

1809LMS

Description:
R14 ball seat



Quantity: 35/box
Finish: Dacromet coat
Hex: M14 x 1.5mm
Thread: 19mm
Overall length: 73mm
Thread length: 22mm
Seat diameter: 26.5mm

DEM SPLINE BOLTS

6 SPLINE

1809LSSPC

Description:
R13 ball seat



Quantity: 35/box
Finish: Chrome
Hex: M14 x 1.5mm
Thread: 6 SPLINE
Overall length: 70mm
Thread length: 45mm
Seat diameter: 22.8mm
Operating Key: 3800/3800s

1809LSSPBK

Description:
R13 ball seat



Quantity: 35/box
Finish: Black coat
Hex: M14 x 1.5mm
Thread: 6 SPLINE
Overall length: 70mm
Thread length: 45mm
Seat diameter: 22.8mm
Operating Key: 3800/3800s

3

Times Chromed
Times The Satisfaction



Aftermarket Wheel Seat Application

DEM SIZE BOLTS

1820S

Description:
60° Cone seat



Quantity: 50/box
Finish: Chrome
Thread: M14 x 1.5mm
Hex: 17mm
Overall length: 50.5mm
Thread length: 24mm
Seat diameter: 22mm

1820SBK

Description:
60° Cone seat



Quantity: 50/box
Finish: Black Coat
Thread: M14 x 1.5mm
Hex: 17mm
Overall length: 50.5mm
Thread length: 24mm
Seat diameter: 22mm

1805

Description:
60° Cone seat



Quantity: 40/box
Finish: Chrome
Thread: M12 x 1.5mm
Hex: 17mm
Overall length: 65.2mm
Thread length: 39mm
Seat diameter: 22.7mm

1806SA

Description:
60° Cone seat



Quantity: 50/box
Finish: Chrome
Thread: M12 x 1.5mm
Hex: 17mm
Overall length: 50mm
Thread length: 22mm
Seat diameter: 22mm

DEM SIZE SPLINE BOLT

6 SPLINE

1820SSPC

Description:
60° Cone seat



Quantity: 50/box
Finish: Chrome
Thread: M14 x 1.5mm
Hex: 6 Spline
Overall length: 54.5mm
Thread length: 24mm
Seat diameter: 20.2mm
Operating key: 3800/3800s

1820SSPBK

Description:
60° Cone seat



Quantity: 50/box
Finish: Black coat
Thread: M14 x 1.5mm
Hex: 6 Spline
Overall length: 54.5mm
Thread length: 24mm
Seat diameter: 20.2mm
Operating key: 3800/3800s

1839SPC

Description:
60° Cone seat



Quantity: 50/box
Finish: Chrome
Thread: M12 x 1.5mm
Hex: 6 Spline
Overall length: 66mm
Thread length: 39mm
Seat diameter: 20.7mm
Operating key: 3800/3800s

1839SPBK

Description:
60° Cone seat



Quantity: 50/box
Finish: Black coat
Thread: M12 x 1.5mm
Hex: 6 Spline
Overall length: 66mm
Thread length: 39mm
Seat diameter: 20.7mm
Operating key: 3800/3800s

DUAL HEX SPLINE KEY

3800S

Description:
6 splines



Quantity: 30/box
Finish: Chrome
Hex: 17mm/19mm
Overall length: 73.1mm
Seat diameter: 20.4mm

3800

Description:
6 splines



Quantity: 20/box
Finish: Chrome/Black
Hex: 19mm/21mm
Overall length: 90mm
Seat diameter: 20.4mm

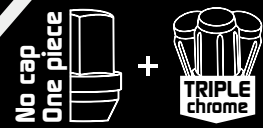

OPEN END CONE SEAT

<p>I307 Description: Open end 60° cone seat Quantity: 100/box Finish: Chrome Thread: M12 x 1.5mm Hex: 19mm Overall length: 16.1mm</p> 	<p>I304 Description: Open end 60° cone seat Quantity: 100/box Finish: Chrome Thread: 1/2" Hex: 19mm Overall length: 16.1mm</p> 	<p>I306 Description: Open end 60° cone seat Quantity: 100/box Finish: Chrome Thread: M12 x 1.25mm Hex: 19mm Overall length: 16.1mm</p> 
--	---	---

OPEN END BULGE SEAT

<p>I307-1S Description: Open end bulge seat Quantity: 100/box Finish: Chrome Thread: M12 x 1.5mm Hex: 19mm Overall length: 21.4mm</p> 	<p>I304-1S Description: Open end bulge seat Quantity: 100/box Finish: Chrome Thread: 1/2" Hex: 19mm Overall length: 21.4mm</p> 	<p>I306-1S Description: Open end bulge seat Quantity: 100/box Finish: Chrome Thread: M12 x 1.25mm Hex: 19mm Overall length: 21.4mm</p> 
--	---	---

CLOSE END CONE SEAT

<p>I004 Description: Close end 60° cone seat Quantity: 50/box Finish: Chrome Thread: 1/2" Hex: 21mm Overall length: 35.3mm</p> 	<p>I006 Description: Close end 60° cone seat Quantity: 50/box Finish: Chrome Thread: M12 x 1.25mm Hex: 21mm Overall length: 35.3mm</p> 	<p>I007 Description: Close end 60° cone seat Quantity: 50/box Finish: Chrome Thread: M12 x 1.5mm Hex: 21mm Overall length: 35.3mm</p> 
---	---	--

CLOSE END BULGE SEAT

<p>I904SL Description: Close end bulge seat Quantity: 40/box Finish: Chrome Thread: 1/2" Hex: 19mm Overall length: 50mm Seat diameter: 23mm</p> 	<p>I906SL Description: Close end bulge seat Quantity: 40/box Finish: Chrome Thread: M12 x 1.25mm Hex: 19mm Overall length: 50mm Seat diameter: 23mm</p> 	<p>I907SL Description: Close end bulge seat Quantity: 40/box Finish: Chrome Thread: M12 x 1.5mm Hex: 19mm Overall length: 50mm Seat diameter: 23mm</p> 
--	--	---

DUPLEX ACORN

5400
Description: Close end Duplex Acorn
Quantity: 30/box
Finish: Chrome
Thread: 1/2"
Hex: 22mm
Overall length: 48.2mm
Seat diameter: 25.5mm



SHORT SHANK DUPLEX ACORN

3004
Description: Close end Duplex Acorn
Quantity: 30/box
Finish: Chrome
Thread: 1/2"
Hex: 22mm
Overall length: 46.6mm
Seat diameter: 21.5mm



OPEN END BULGE SEAT 6 SPLINE

<p>3807-1C Description: Open end bulge seat Quantity: 100 Finish: Chrome Thread: M12 x 1.5mm Hex: 6 SPLINE Overall length: 21mm Seat diameter: 20.2mm Operating key: 3800/3800s</p> 	<p>3804-1C Description: Open end bulge seat Quantity: 100 Finish: Chrome Thread: 1/2" Hex: 6 SPLINE Overall length: 21mm Seat diameter: 20.2mm Operating key: 3800/3800s</p> 	<p>3806-1C Description: Open end bulge seat Quantity: 100 Finish: Chrome Thread: M12 x 1.25mm Hex: 6 SPLINE Overall length: 21mm Seat diameter: 20.2mm Operating key: 3800/3800s</p> 
--	---	---

CLOSE END BULGE SEAT 6 SPLINE

<p>3804-LC Description: Close end bulge seat Quantity: 40/box Finish: Chrome Thread: 1/2" Hex: 6 SPLINE Overall length: 50.5mm Seat diameter: 23.1mm Operating key: 3800LD</p> 	<p>3804-LBK Description: Close end bulge seat Quantity: 40/box Finish: Black coat Thread: 1/2" Hex: 6 SPLINE Overall length: 50.5mm Seat diameter: 23.1mm Operating key: 3800LD</p> 	<p>3807-LC Description: Close end bulge seat Quantity: 40/box Finish: Chrome Thread: M12 x 1.5mm Hex: 6 SPLINE Overall length: 50.5mm Seat diameter: 23.1mm Operating key: 3800LD</p> 	<p>3807-LBK Description: Close end bulge seat Quantity: 40/box Finish: Black coat Thread: M12 x 1.5mm Hex: 6 SPLINE Overall length: 50.5mm Seat diameter: 23.1mm Operating key: 3800LD</p> 
---	--	--	---

DUAL HEX SPLINE KEY

<p>3800S Description: 6 splines Quantity: 30/box Finish: Chrome Hex: 17mm/19mm Overall length: 73.1mm Seat diameter: 20.4mm</p> 	<p>3800 Description: 6 splines Quantity: 20/box Finish: Chrome/Black Hex: 19mm/21mm Overall length: 90mm Seat diameter: 20.4mm</p> 
--	---

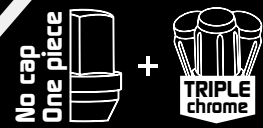

EPICOR & Ready Online!

OEM BOLTS

1821-I Description: 60° Cone seat Quantity: 50/box Finish: Chrome Thread: M14 x 1.25mm Hex: 17mm Overall length: 48mm Thread length: 22mm Seat diameter: 22mm		1821-1BK Description: 60° Cone seat Quantity: 50/box Finish: Black coat Thread: M14 x 1.25mm Hex: 17mm Overall length: 48mm Thread length: 22mm Seat diameter: 22mm		1806 Description: 60° Cone seat Quantity: 50/box Finish: Chrome Thread: M12 x 1.5mm Hex: 17mm Overall length: 52.2mm Thread length: 24mm Seat diameter: 22.7mm		1806BK Description: 60° Cone seat Quantity: 50/box Finish: Black coat Thread: M12 x 1.5mm Hex: 17mm Overall length: 52.2mm Thread length: 24mm Seat diameter: 22.7mm	
---	---	---	---	--	--	--	---

OEM SPLINE BOLTS 6 SPLINE

1802SPC Description: 60° Cone seat Quantity: 50/box Finish: Chrome Thread: M14 x 1.25mm Hex: 6 SPLINE Overall length: 51.3mm Thread length: 24mm Seat diameter: 20.5mm Operating key: 3800/3800S		1802SPBK Description: 60° Cone seat Quantity: 50/box Finish: Black coat Thread: M14 x 1.25mm Hex: 6 SPLINE Overall length: 51.3mm Thread length: 24mm Seat diameter: 20.5mm Operating key: 3800/3800S		1806SPC Description: 60° Cone seat Quantity: 50/box Finish: Chrome Thread: M12 x 1.5 mm Hex: 6 SPLINE Overall length: 48.4mm Thread length: 24mm Seat diameter: 21mm Operating key: 3800/3800S		1806SPBK Description: 60° Cone seat Quantity: 50/box Finish: Black coat Thread: M12 x 1.5 mm Hex: 6 SPLINE Overall length: 48.4mm Thread length: 24mm Seat diameter: 21mm Operating key: 3800/3800S	
--	---	---	---	--	--	---	---

DUAL HEX 6 SPLINE KEY

3800S Description: 6 splines 	3800 Description: 6 splines 
Quantity: 30/box Finish: Chrome Hex: 17mm/19mm Overall length: 73.1mm Seat diameter: 20.4mm	Quantity: 20/box Finish: Chrome/Black Hex: 19mm/21mm Overall length: 90mm Seat diameter: 20.4mm

OEM Wheel Seat Application

OEM NUTS

5301M Description: Close end shank seat with washer Quantity: 40/box Finish: Chrome Thread: M12 x 1.5mm Hex: 21mm Overall length: 36.8mm Seat diameter: 18.3mm Washer diameter: 30mm		5307 Description: Close end shank seat with washer Quantity: 40/box Finish: Chrome Thread: M12 x 1.5mm Hex: 21mm Overall length: 37mm Seat diameter: 18.3mm Washer diameter: 30mm		5307BK Description: Close end shank seat with washer Quantity: 40/box Finish: Black coat Thread: M12 x 1.5mm Hex: 21mm Overall length: 37mm Seat diameter: 18.3mm Washer diameter: 30mm		5305 Description: Close end bulge seat Quantity: 35/box Finish: Chrome Thread: 9/16" Hex: 22mm Overall length: 37.8mm Seat diameter: 25mm	
5305BK Description: Close end bulge seat Quantity: 35/box Finish: Black coat Thread: 9/16" Hex: 22mm Overall length: 37.8mm Seat diameter: 25mm							

Aftermarket Wheel Seat Application

OPEN END CONE SEAT

1327 Description: Open end 60° cone seat Quantity: 100/box Finish: Chrome Thread: M12 x 1.5mm Hex: 21mm Overall length: 16mm	
--	---

OPEN END BULGE SEAT

1307-1 Description: Open end bulge seat Quantity: 80/box Finish: Chrome Thread: M12 x 1.5mm Hex: 21mm Overall length: 21mm		1313 Description: Open end bulge seat Quantity: 70/box Finish: Chrome Thread: 9/16" Hex: 22mm Overall length: 21.4mm	
--	---	--	---



CLOSE END CONE SEAT

1007 Description: Close end 60° cone seat Quantity: 50/box Finish: Chrome Thread: M12 x 1.5mm Hex: 21mm Overall length: 35.3mm	
--	---

CLOSE END BULGE SEAT

1907 Description: Close end bulge seat Quantity: 50/box Finish: Chrome Thread: M12 x 1.5mm Hex: 21mm Overall length: 34.7mm Seat diameter: 24mm		1907BK Description: Close end bulge seat Quantity: 50/box Finish: Black coat Thread: M12 x 1.5mm Hex: 21mm Overall length: 34.7mm Seat diameter: 24mm	
---	---	---	---

DUPLEX ACORN

5402 Description: Close end Duplex Acorn Quantity: 30/box Finish: Chrome Thread: 9/16" Hex: 22mm Overall length: 48.2mm Seat diameter: 25.5mm		3010 Description: Close end Duplex Acorn Quantity: 30/box Finish: Chrome Thread: 9/16" Hex: 22mm Overall length: 46.6mm Seat diameter: 21.5mm	
---	---	---	---

MITSUBISHI

MITSUBISHI

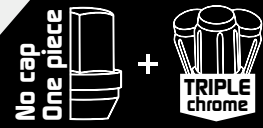

EPICOR & **TWH**
Ready Online!

Aftermarket Wheel Seat Application

OPEN END BULGE SEAT

3807-1C 6 SPLINE

Description: Open end bulge seat
Quantity: 100
Finish: Chrome
Thread: M12 x 1.5mm
Hex: 6 SPLINE
Overall length: 21mm
Seat diameter: 20.2mm
Operating key: 3800/3800s



OPEN END BULGE SEAT

3810-1DC 7 SPLINE

Description: Open end bulge seat
Quantity: 80/box
Finish: Chrome
Thread: 9/16"
Hex: 7 SPLINE
Overall length: 25.3mm
Seat diameter: 23.3mm
Operating key: 3800L



CLOSE END BULGE SEAT 7 SPLINE

3810-DC

Description: Close end bulge seat
Quantity: 40/box
Finish: Chrome
Thread: 9/16"
Hex: 7 SPLINE
Overall length: 43.1mm
Seat diameter: 19.4mm
Operating key: 3800L



3810-DBK

Description: Close end bulge seat
Quantity: 40/box
Finish: Black Coat
Thread: 9/16"
Hex: 7 SPLINE
Overall length: 43.1mm
Seat diameter: 19.4mm
Operating key: 3800L



CLOSE END BULGE SEAT 6 SPLINE

3807-C

Description: Close end bulge seat
Quantity: 80/box
Finish: Chrome
Thread: M12 x 1.5mm
Hex: 6 SPLINE
Overall length: 33.2mm
Seat diameter: 20.2mm
Operating key: 3800/3800s



3807-BK

Description: Close end bulge seat
Quantity: 80/box
Finish: Black coat
Thread: M12 x 1.5mm
Hex: 6 SPLINE
Overall length: 33.2mm
Seat diameter: 21mm
Operating key: 3800/3800s



3807-LC

Description: Close end bulge seat
Quantity: 40/box
Finish: Chrome
Thread: M12 x 1.5mm
Hex: 6 SPLINE
Overall length: 50.5mm
Seat diameter: 23.1mm
Operating key: 3800LD



3807-LBK

Description: Close end bulge seat
Quantity: 40/box
Finish: Black coat
Thread: M12 x 1.5mm
Hex: 6 SPLINE
Overall length: 50.5mm
Seat diameter: 23.1mm
Operating key: 3800LD



TUNER NUT

2807

Description: Inverted hex tuner nut
Quantity: 50/box
Finish: Chrome
Thread: M12 x 1.5mm
Hex: 12mm
Overall length: 32.6mm
Seat diameter: 20mm
Operating key: 2800



2807 BK

Description: Inverted hex tuner nut
Quantity: 50/box
Finish: Black coat
Thread: M12 x 1.5mm
Hex: 12mm
Overall length: 32.6mm
Seat diameter: 20mm
Operating key: 2800



DUAL HEX TUNER KEY

2800

Quantity: 30/box
Finish: Chrome
Hex: 19mm/21mm
Key Hex: 12mm
Overall length: 57.9mm



DUAL HEX SPLINE KEY

3800S

Description: 6 splines
Quantity: 30/box
Finish: Chrome
Hex: 17mm/19mm
Overall length: 73.1mm
Seat diameter: 20.4mm



3800

Description: 6 splines
Quantity: 20/box
Finish: Chrome/Black
Hex: 19mm/21mm
Overall length: 90mm
Seat diameter: 20.4mm



3800L

Description: 7 splines
Quantity: 20/box
Finish: Chrome/Black
Hex: 21mm/22mm
Overall length: 82mm
Seat diameter: 23mm



3800LD

Description: 6 splines
Quantity: 20/box
Finish: Chrome/Black
Hex: 21mm/22mm
Overall length: 82mm
Seat diameter: 23.3mm



OEM Wheel Seat Application

OEM NUTS

5306

Description: Close end shank seat with washer
Quantity: 40/box
Finish: Chrome
Thread: M12 x 1.25mm
Hex: 21mm
Overall length: 37mm
Seat diameter: 18.3mm
Washer diameter: 30mm



5306BK

Description: Close end shank seat with washer
Quantity: 40/box
Finish: Black coat
Thread: M12 x 1.25mm
Hex: 21mm
Overall length: 37mm
Seat diameter: 18.3mm
Washer diameter: 30mm



114

Description: Close end 60° cone seat
Quantity: 50/box
Finish: Chrome
Thread: M12 x 1.25mm
Hex: 21mm
Overall length: 30mm



1326

Description: Open end 60° cone seat
Quantity: 100/box
Finish: Chrome
Thread: M12 x 1.25mm
Hex: 21mm
Overall length: 16mm



Aftermarket Wheel Seat Application

OPEN END BULGE SEAT

1306-1

Description: Open end bulge seat
Quantity: 80/box
Finish: Chrome
Thread: M12 x 1.25mm
Hex: 21mm
Overall length: 21mm



CLOSE END CONE SEAT

1006

Description: Close end 60° cone seat
Quantity: 50/box
Finish: Chrome
Thread: M12 x 1.25mm
Hex: 21mm
Overall length: 35.3mm



CLOSE END BULGE SEAT

1906

Description: Close end bulge seat
Quantity: 50/box
Finish: Chrome
Thread: M12 x 1.25mm
Hex: 21mm
Overall length: 34.7mm
Seat diameter: 24mm



1906SL

Description: Close end bulge seat
Quantity: 40/box
Finish: Chrome
Thread: M12 x 1.25mm
Hex: 19mm
Overall length: 50mm
Seat diameter: 23mm



OPEN END BULGE SEAT 6 SPLINE

3806-1C

Description: Open end bulge seat
Quantity: 100
Finish: Chrome
Thread: M12 x 1.25mm
Hex: 6 SPLINE
Overall length: 21mm
Seat diameter: 20.2mm
Operating key: 3800/3800s



CLOSE END BULGE SEAT 6 SPLINE

3806-C

Description: Close end bulge seat
Quantity: 80/box
Finish: Chrome
Thread: M12 x 1.25mm
Hex: 6 SPLINE
Overall length: 33.2mm
Seat diameter: 20.2mm
Operating key: 3800/3800s



3806-BK

Description: Close end bulge seat
Quantity: 80/box
Finish: Black coat
Thread: M12 x 1.25mm
Hex: 6 SPLINE
Overall length: 33.2mm
Seat diameter: 21mm
Operating key: 3800/3800s



TUNER NUT

2806

Description: Inverted hex tuner nut
Quantity: 50/box
Finish: Chrome
Thread: M12 x 1.25mm
Hex: 12mm
Overall length: 32.6mm
Seat diameter: 20mm
Operating key: 2800



DUAL HEX SPLINE KEY

3800S

Description: 6 splines
Quantity: 30/box
Finish: Chrome
Hex: 17mm/19mm
Overall length: 73.1mm
Seat diameter: 20.4mm



3800

Description: 6 splines
Quantity: 20/box
Finish: Chrome/Black
Hex: 19mm/21mm
Overall length: 90mm
Seat diameter: 20.4mm



DUAL HEX TUNER KEY

2800

Quantity: 30/box
Finish: Chrome
Hex: 19mm/21mm
Key Hex: 12mm
Overall length: 57.9mm



NISSAN

NISSAN

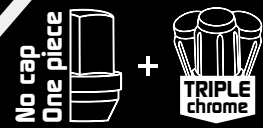

DEM COVER RETAINING NUT

2006S
Description: Open end Cap retaining thread
Quantity: 50/box
Finish: Zink plated
Thread: M12 x 1.5mm
Hex: 19mm
Overall length: 31.8mm
Seat diameter: 22.6mm
Cap retaining thread: M24 x 2.0mm



OPEN END CONE SEAT

I307
Description: Open end 60° cone seat
Quantity: 100/box
Finish: Chrome
Thread: M12 x 1.5mm
Hex: 19mm
Overall length: 16.1mm



OPEN END BULGE SEAT

I307-1S
Description: Open end bulge seat
Quantity: 100/box
Finish: Chrome
Thread: M12 x 1.5mm
Hex: 19mm
Overall length: 21.4mm



CLOSE END CONE SEAT

I007
Description: Close end 60° cone seat
Quantity: 50/box
Finish: Chrome
Thread: M12 x 1.5mm
Hex: 21mm
Overall length: 35.3mm



OPEN END BULGE SEAT

3807-1C 6 SPLINE
Description: Open end bulge seat
Quantity: 100
Finish: Chrome
Thread: M12 x 1.5mm
Hex: 6 SPLINE
Overall length: 21mm
Seat diameter: 20.2mm
Operating key: 3800/3800s



CLOSE END BULGE SEAT

I907S
Description: Close end bulge seat
Quantity: 50/box
Finish: Chrome
Thread: M12 x 1.5mm
Hex: 19mm
Overall length: 34.7mm
Seat diameter: 22mm



I707BK
Description: Close end bulge seat
Quantity: 50/box
Finish: Black Coat
Thread: M12 x 1.5mm
Hex: 19mm
Overall length: 34.5mm
Seat diameter: 22mm



CLOSE END BULGE SEAT 6 SPLINE

3807-C
Description: Close end bulge seat
Quantity: 80/box
Finish: Chrome
Thread: M12 x 1.5mm
Hex: 6 SPLINE
Overall length: 33.2mm
Seat diameter: 20.2mm
Operating key: 3800/3800s



3807-BK
Description: Close end bulge seat
Quantity: 80/box
Finish: Black coat
Thread: M12 x 1.5mm
Hex: 6 SPLINE
Overall length: 33.2mm
Seat diameter: 21mm
Operating key: 3800/3800s



TUNER NUT

2807
Description: Inverted hex tuner nut
Quantity: 50/box
Finish: Chrome
Thread: M12 x 1.5mm
Hex: 12mm
Overall length: 32.6mm
Seat diameter: 20mm
Operating key: 2800



2807 BK
Description: Inverted hex tuner nut
Quantity: 50/box
Finish: Black coat
Thread: M12 x 1.5mm
Hex: 12mm
Overall length: 32.6mm
Seat diameter: 20mm
Operating key: 2800



DUAL HEX SPLINE KEY

3800S
Description: 6 splines
Quantity: 30/box
Finish: Chrome
Hex: 17mm/19mm
Overall length: 73.1mm
Seat diameter: 20.4mm



3800
Description: 6 splines
Quantity: 20/box
Finish: Chrome/Black
Hex: 19mm/21mm
Overall length: 90mm
Seat diameter: 20.4mm



DUAL HEX TUNER KEY

2800
Quantity: 30/box
Finish: Chrome
Hex: 19mm/21mm
Key Hex: 12mm
Overall length: 57.9mm



DEM COVER RETAINING NUT

2006S
Description: Open end Cap retaining thread
Quantity: 50/box
Finish: Zink plated
Thread: M12 x 1.5mm
Hex: 19mm
Overall length: 31.8mm
Seat diameter: 22.6mm
Cap retaining thread: M24 x 2.0mm



No cap
One piece



OPEN END CONE SEAT

I307
Description: Open end 60° cone seat
Quantity: 100/box
Finish: Chrome
Thread: M12 x 1.5mm
Hex: 19mm
Overall length: 16.1mm



OPEN END BULGE SEAT

I307-1S
Description: Open end bulge seat
Quantity: 100/box
Finish: Chrome
Thread: M12 x 1.5mm
Hex: 19mm
Overall length: 21.4mm



CLOSE END CONE SEAT

I007
Description: Close end 60° cone seat
Quantity: 50/box
Finish: Chrome
Thread: M12 x 1.5mm
Hex: 21mm
Overall length: 35.3mm



OPEN END BULGE SEAT 6 SPLINE

3807-1C
Description: Open end bulge seat
Quantity: 100
Finish: Chrome
Thread: M12 x 1.5mm
Hex: 6 SPLINE
Overall length: 21mm
Seat diameter: 20.2mm
Operating key: 3800/3800s



CLOSE END BULGE SEAT

I907S
Description: Close end bulge seat
Quantity: 50/box
Finish: Chrome
Thread: M12 x 1.5mm
Hex: 19mm
Overall length: 34.7mm
Seat diameter: 22mm



I707BK
Description: Close end bulge seat
Quantity: 50/box
Finish: Black Coat
Thread: M12 x 1.5mm
Hex: 19mm
Overall length: 34.5mm
Seat diameter: 22mm



CLOSE END BULGE SEAT 6 SPLINE

3807-C
Description: Close end bulge seat
Quantity: 80/box
Finish: Chrome
Thread: M12 x 1.5mm
Hex: 6 SPLINE
Overall length: 33.2mm
Seat diameter: 20.2mm
Operating key: 3800/3800s



3807-BK
Description: Close end bulge seat
Quantity: 80/box
Finish: Black coat
Thread: M12 x 1.5mm
Hex: 6 SPLINE
Overall length: 33.2mm
Seat diameter: 21mm
Operating key: 3800/3800s



DUAL HEX SPLINE KEY

3800S
Description: 6 splines
Quantity: 30/box
Finish: Chrome
Hex: 17mm/19mm
Overall length: 73.1mm
Seat diameter: 20.4mm



3800
Description: 6 splines
Quantity: 20/box
Finish: Chrome/Black
Hex: 19mm/21mm
Overall length: 90mm
Seat diameter: 20.4mm



DUAL HEX TUNER KEY

2800
Quantity: 30/box
Finish: Chrome
Hex: 19mm/21mm
Key Hex: 12mm
Overall length: 57.9mm



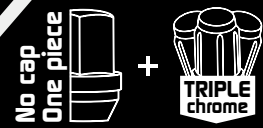

EPICOR & **Ready Online!**

DEM COVER RETAINING NUT

2007S

Description: Open end Cap retaining thread
Quantity: 50/box
Finish: Zink plated
Thread: M12 x 1.5mm
Hex: 19mm
Overall length: 27mm
Seat diameter: 22.6mm
Cap retaining thread: M24 x 2.0mm



2006S

Description: Open end Cap retaining thread
Quantity: 50/box
Finish: Zink plated
Thread: M12 x 1.5mm
Hex: 19mm
Overall length: 31.8mm
Seat diameter: 22.6mm
Cap retaining thread: M24 x 2.0mm



OPEN END CONE SEAT

I307

Description: Open end 60° cone seat
Quantity: 100/box
Finish: Chrome
Thread: M12 x 1.5mm
Hex: 19mm
Overall length: 16.1mm



I327

Description: Open end 60° cone seat
Quantity: 100/box
Finish: Chrome
Thread: M12 x 1.5mm
Hex: 19mm
Overall length: 16mm



CLOSE END CONE SEAT

I007

Description: Close end 60° cone seat
Quantity: 50/box
Finish: Chrome
Thread: M12 x 1.5mm
Hex: 21mm
Overall length: 35.3mm



OPEN END BULGE SEAT

I307-IS

Description: Open end bulge seat
Quantity: 100/box
Finish: Chrome
Thread: M12 x 1.5mm
Hex: 19mm
Overall length: 21.4mm



I307-I

Description: Open end bulge seat
Quantity: 80/box
Finish: Chrome
Thread: M12 x 1.5mm
Hex: 21mm
Overall length: 21mm



I312

Description: Open end bulge seat
Quantity: 70/box
Finish: Chrome
Thread: M14 x 1.5mm
Hex: 22mm
Overall length: 21.4mm



CLOSE END BULGE SEAT

I907S

Description: Close end bulge seat
Quantity: 50/box
Finish: Chrome
Thread: M12 x 1.5mm
Hex: 19mm
Overall length: 34.7mm
Seat diameter: 22mm



I707BK

Description: Close end bulge seat
Quantity: 50/box
Finish: Black Coat
Thread: M12 x 1.5mm
Hex: 19mm
Overall length: 34.5mm
Seat diameter: 22mm



I907

Description: Close end bulge seat
Quantity: 50/box
Finish: Chrome
Thread: M12 x 1.5mm
Hex: 21mm
Overall length: 34.7mm
Seat diameter: 24mm



I907BK

Description: Close end bulge seat
Quantity: 50/box
Finish: Black coat
Thread: M12 x 1.5mm
Hex: 21mm
Overall length: 34.7mm
Seat diameter: 24mm



I909

Description: Close end bulge
Quantity: 50/box
Finish: Chrome
Thread: M14 x 1.5mm
Hex: 21mm
Overall length: 34.7mm
Seat diameter: 24mm



DUPLEX ACORN

540I

Description: Close end Duplex Acorn
Quantity: 30/box
Finish: Chrome
Thread: M14 x 1.5mm
Hex: 22mm
Overall length: 48.2mm
Seat diameter: 25.5mm



540IBK

Description: Close end Duplex Acorn
Quantity: 30/box
Finish: Black coat
Thread: M14 x 1.5mm
Hex: 22mm
Overall length: 48.2mm
Seat diameter: 25.5mm



SHORT SHANK DUPLEX ACORN

3009

Description: Close end Duplex Acorn
Quantity: 30/box
Finish: Chrome
Thread: M14 x 1.5mm
Hex: 22mm
Overall length: 46.6mm
Seat diameter: 21.5mm



OPEN END BULGE SEAT

3807-1C

Description: Open end bulge seat
Quantity: 100
Finish: Chrome
Thread: M12 x 1.5mm
Hex: 6 SPLINE
Overall length: 21mm
Seat diameter: 20.2mm
Operating key: 3800/3800s



CLOSE END BULGE SEAT 6 SPLINE

3807-C

Description: Close end bulge seat
Quantity: 80/box
Finish: Chrome
Thread: M12 x 1.5mm
Hex: 6 SPLINE
Overall length: 33.2mm
Seat diameter: 20.2mm
Operating key: 3800/3800s



3807-BK

Description: Close end bulge seat
Quantity: 80/box
Finish: Black coat
Thread: M12 x 1.5mm
Hex: 6 SPLINE
Overall length: 33.2mm
Seat diameter: 21mm
Operating key: 3800/3800s



CLOSE END BULGE SEAT 7 SPLINE

3809-DLC

Description: Close end bulge seat
Quantity: 40/box
Finish: Chrome
Thread: M14 x 1.5mm
Hex: 7 SPLINE
Overall length: 51.7mm
Seat diameter: 23mm
Operating key: 3800L



3809-DLBC

Description: Close end bulge seat
Quantity: 40/box
Finish: Black Coat
Thread: M14 x 1.5mm
Hex: 7 SPLINE
Overall length: 51.7mm
Seat diameter: 23mm
Operating key: 3800L



OPEN END BULGE SEAT 7 SPLINE

3809-IDC

Description: Open end bulge seat
Quantity: 80/box
Finish: Chrome
Thread: M14 x 1.5mm
Hex: 7 SPLINE
Overall length: 25.4mm
Seat diameter: 23.3mm
Operating key: 3800L



DUAL HEX SPLINE KEY

3800S

Description: 6 splines
Quantity: 30/box
Finish: Chrome
Hex: 17mm/19mm
Overall length: 73.1mm
Seat diameter: 20.4mm



3800

Description: 6 splines
Quantity: 20/box
Finish: Chrome/Black
Hex: 19mm/21mm
Overall length: 90mm
Seat diameter: 20.4mm



3800L

Description: 7 splines
Quantity: 20/box
Finish: Chrome/Black
Hex: 21mm/22mm
Overall length: 82mm
Seat diameter: 23mm



TUNER NUT

2807

Description: Inverted hex tuner nut
Quantity: 50/box
Finish: Chrome
Thread: M12 x 1.5mm
Hex: 12mm
Overall length: 32.6mm
Seat diameter: 20mm
Operating key: 2800



2807 BK

Description: Inverted hex tuner nut
Quantity: 50/box
Finish: Black coat
Thread: M12 x 1.5mm
Hex: 12mm
Overall length: 32.6mm
Seat diameter: 20mm
Operating key: 2800



2807 L

Description: Inverted hex tuner nut
Quantity: 25/box
Finish: Chrome
Thread: M14 x 1.5mm
Hex: 15mm
Overall length: 45.4mm
Seat diameter: 20mm
Operating key: 2800L

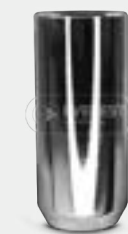

DUAL HEX TUNER KEY

2800

Quantity: 30/box
Finish: Chrome
Hex: 19mm/21mm
Key Hex: 12mm
Overall length: 57.9mm



2800L

Quantity: 30/box
Finish: Chrome
Hex: 19mm/21mm
Key Hex: 14.7mm
Overall length: 63.5mm



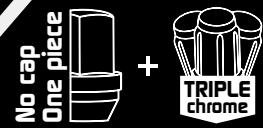

EPICOR & WHI
Ready Online!

DEM NUTS

5330

Description: Close end bulge seat
Quantity: 30/box
Finish: Chrome
Thread: M14 x 1.5mm
Hex: 22mm
Overall length: 38.3mm
Seat diameter: 25mm



5330BK

Description: Close end bulge seat
Quantity: 30/box
Finish: Black coat
Thread: M14 x 1.5mm
Hex: 22mm
Overall length: 38.3mm
Seat diameter: 25mm



5302S

Description: Close end 60° cone seat
Quantity: 30/box
Finish: Chrome
Thread: M12 x 1.25mm
Hex: 19mm
Overall length: 25.4mm
Seat diameter: 20.8mm



DEM SPLINE BOLTS

6 SPLINE

1806SPC

Description: 60° Cone seat
Quantity: 50/box
Finish: Chrome
Thread: M12 x 1.5 mm
Hex: 6 SPLINE
Overall length: 48.4mm
Thread length: 24mm
Seat diameter: 21mm
Operating key: 3800/3800S



1806SPBK

Description: 60° Cone seat
Quantity: 50/box
Finish: Black coat
Thread: M12 x 1.5 mm
Hex: 6 SPLINE
Overall length: 48.4mm
Thread length: 24mm
Seat diameter: 21mm
Operating key: 3800/3800S



DEM BOLTS

1806

Description: 60° Cone seat
Quantity: 50/box
Finish: Chrome
Thread: M12 x 1.5mm
Hex: 17mm
Overall length: 52.2mm
Thread length: 24mm
Seat diameter: 22.7mm



1806BK

Description: 60° Cone seat
Quantity: 50/box
Finish: Black coat
Thread: M12 x 1.5mm
Hex: 17mm
Overall length: 52.2mm
Thread length: 24mm
Seat diameter: 22.7mm



OPEN END CONE SEAT

1307

Description: Open end 60° cone seat
Quantity: 100/box
Finish: Chrome
Thread: M12 x 1.5mm
Hex: 19mm
Overall length: 16.1mm



1306

Description: Open end 60° cone seat
Quantity: 100/box
Finish: Chrome
Thread: M12 x 1.25mm
Hex: 19mm
Overall length: 16.1mm



CLOSE END CONE SEAT

1006

Description: Close end 60° cone seat
Quantity: 50/box
Finish: Chrome
Thread: M12 x 1.25mm
Hex: 21mm
Overall length: 35.3mm



1007

Description: Close end 60° cone seat
Quantity: 50/box
Finish: Chrome
Thread: M12 x 1.5mm
Hex: 21mm
Overall length: 35.3mm



OPEN END BULGE SEAT

1307-1S

Description: Open end bulge seat
Quantity: 100/box
Finish: Chrome
Thread: M12 x 1.5mm
Hex: 19mm
Overall length: 21.4mm



1312

Description: Open end bulge seat
Quantity: 70/box
Finish: Chrome
Thread: M14 x 1.5mm
Hex: 22mm
Overall length: 21.4mm



1306-1S

Description: Open end bulge seat
Quantity: 100/box
Finish: Chrome
Thread: M12 x 1.25mm
Hex: 19mm
Overall length: 21.4mm



CLOSE END BULGE SEAT

1907S

Description: Close end bulge seat
Quantity: 50/box
Finish: Chrome
Thread: M12 x 1.5mm
Hex: 19mm
Overall length: 34.7mm
Seat diameter: 22mm



CLOSE END BULGE SEAT

1707BK

Description: Close end bulge seat
Quantity: 50/box
Finish: Black Coat
Thread: M12 x 1.5mm
Hex: 19mm
Overall length: 34.5mm
Seat diameter: 22mm



1906

Description: Close end bulge seat
Quantity: 50/box
Finish: Chrome
Thread: M12 x 1.25mm
Hex: 19mm
Overall length: 34.7mm
Seat diameter: 24mm



1906SL

Description: Close end bulge seat
Quantity: 40/box
Finish: Chrome
Thread: M12 x 1.25mm
Hex: 19mm
Overall length: 50mm
Seat diameter: 23mm



SHORT SHANK DUPLEX ACORN

3009

Description: Close end Duplex Acorn
Quantity: 30/box
Finish: Chrome
Thread: M14 x 1.5mm
Hex: 22mm
Overall length: 46.6mm
Seat diameter: 21.5mm



DUPLEX ACORN

5401

Description: Close end Duplex Acorn
Quantity: 30/box
Finish: Chrome
Thread: M14 x 1.5mm
Hex: 22mm
Overall length: 48.2mm
Seat diameter: 25.5mm



5401BK

Description: Close end Duplex Acorn
Quantity: 30/box
Finish: Black coat
Thread: M14 x 1.5mm
Hex: 22mm
Overall length: 48.2mm
Seat diameter: 25.5mm



CLOSE END BULGE SEAT 6 SPLINE

3807-C

Description: Close end bulge seat
Quantity: 80/box
Finish: Chrome
Thread: M12 x 1.5mm
Hex: 6 SPLINE
Overall length: 33.2mm
Seat diameter: 20.2mm
Operating key: 3800/3800S



3807-BK

Description: Close end bulge seat
Quantity: 80/box
Finish: Black coat
Thread: M12 x 1.5mm
Hex: 6 SPLINE
Overall length: 33.2mm
Seat diameter: 21mm
Operating key: 3800/3800S



OPEN END BULGE SEAT

3807-1C

Description: Open end bulge seat
Quantity: 100
Finish: Chrome
Thread: M12 x 1.5mm
Hex: 6 SPLINE
Overall length: 21mm
Seat diameter: 20.2mm
Operating key: 3800/3800S



6 SPLINE

3809-DLC

Description: Close end bulge seat
Quantity: 40/box
Finish: Chrome
Thread: M14 x 1.5mm
Hex: 7 SPLINE
Overall length: 51.7mm
Seat diameter: 23mm
Operating key: 3800L



3809-DLBK

Description: Close end bulge seat
Quantity: 40/box
Finish: Black Coat
Thread: M14 x 1.5mm
Hex: 7 SPLINE
Overall length: 51.7mm
Seat diameter: 23mm
Operating key: 3800L



OPEN END BULGE SEAT

3809-1DC

Description: Open end bulge seat
Quantity: 80/box
Finish: Chrome
Thread: M14 x 1.5mm
Hex: 7 SPLINE
Overall length: 25.4mm
Seat diameter: 23.3mm
Operating key: 3800L



7 SPLINE

DUAL HEX SPLINE KEY

3800S

Description: 6 splines
Quantity: 30/box
Finish: Chrome
Hex: 17mm/19mm
Overall length: 73.1mm
Seat diameter: 20.4mm



3800

Description: 6 splines
Quantity: 20/box
Finish: Chrome/Black
Hex: 19mm/21mm
Overall length: 90mm
Seat diameter: 20.4mm



3800L

Description: 7 splines
Quantity: 20/box
Finish: Chrome/Black
Hex: 21mm/22mm
Overall length: 82mm
Seat diameter: 23mm



DUAL HEX TUNER KEY

2800

Description:
Quantity: 30/box
Finish: Chrome
Hex: 19mm/21mm
Key Hex: 12mm
Overall length: 57.9mm



TUNER NUT

2807

Description: Inverted hex tuner nut
Quantity: 50/box
Finish: Chrome
Thread: M12 x 1.5mm
Hex: 12mm
Overall length: 32.6mm
Seat diameter: 20mm
Operating key: 2800



2807 BK

Description: Inverted hex tuner nut
Quantity: 50/box
Finish: Black coat
Thread: M12 x 1.5mm
Hex: 12mm
Overall length: 32.6mm
Seat diameter: 20mm
Operating key: 2800



2807 L

Description: Inverted hex tuner nut
Quantity: 25/box
Finish: Chrome
Thread: M14 x 1.5mm
Hex: 15mm
Overall length: 45.4mm
Seat diameter: 20mm
Operating key: 2800L



2800L

Description:
Quantity: 30/box
Finish: Chrome
Hex: 19mm/21mm
Key Hex: 14.7mm
Overall length: 63.5mm



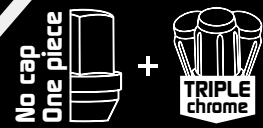

DEM BOLT

18085M

Description:
R13 ball seat



Quantity: 50/box
Finish: Dacromat coat
Hex: M12 x 1.5mm
Thread: 17mm
Overall length: 39mm
Thread length: 19mm
Seat diameter: 22.7mm

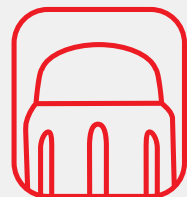

DEM NUT

53025

Description:
Close end 60° cone seat



Quantity: 30/box
Finish: Chrome
Thread: M12 x 1.25mm
Hex: 19m
Overall length: 25.4mm
Seat diameter: 20.8mm

OPEN END CONE SEAT

1306

Description:
Open end 60° cone seat



Quantity: 100/box
Finish: Chrome
Thread: M12 x 1.25mm
Hex: 19mm
Overall length: 16.1mm

OPEN END BULGE SEAT

1306-1S

Description:
Open end bulge seat



Quantity: 100/box
Finish: Chrome
Thread: M12 x 1.25mm
Hex: 19mm
Overall length: 21.4mm

CLOSE END CONE SEAT

1006

Description:
Close end 60° cone seat



Quantity: 50/box
Finish: Chrome
Thread: M12 x 1.25mm
Hex: 21mm
Overall length: 35.3mm

CLOSE END BULGE SEAT

1906S

Description:
Close end bulge seat



Quantity: 50/box
Finish: Chrome
Thread: M12 x 1.25mm
Hex: 19mm
Overall length: 35.6mm
Seat diameter: 22mm

OPEN END BULGE SEAT 6 SPLINE

3806-1C 6 SPLINE

Description:
Open end bulge seat



Quantity: 100
Finish: Chrome
Thread: M12 x 1.25mm
Hex: 6 SPLINE
Overall length: 21mm
Seat diameter: 20.2mm
Operating key: 3800/3800s

CLOSE END BULGE SEAT 6 SPLINE

3806-C

Description:
Close end bulge seat



Quantity: 80/box
Finish: Chrome
Thread: M12 x 1.25mm
Hex: 6 SPLINE
Overall length: 33.2mm
Seat diameter: 20.2mm
Operating key: 3800/3800s

3806-BK

Description:
Close end bulge seat



Quantity: 80/box
Finish: Black coat
Thread: M12 x 1.25mm
Hex: 6 SPLINE
Overall length: 33.2mm
Seat diameter: 21mm
Operating key: 3800/3800s

TUNER NUT

2806

Description:
Inverted hex tuner nut



Quantity: 50/box
Finish: Chrome
Thread: M12 x 1.25mm
Hex: 12mm
Overall length: 32.6mm
Seat diameter: 20mm
Operating key: 2800

DUAL HEX 6 SPLINE KEY

3800S

Description:
6 splines



Quantity: 30/box
Finish: Chrome
Hex: 17mm/19mm
Overall length: 73.1mm
Seat diameter: 20.4mm

3800

Description:
6 splines



Quantity: 20/box
Finish: Chrome/Black
Hex: 19mm/21mm
Overall length: 90mm
Seat diameter: 20.4mm

DUAL HEX TUNER KEY

2800



Quantity: 30/box
Finish: Chrome
Hex: 19mm/21mm
Key Hex: 12mm
Overall length: 57.9mm

SUBARU

SUBARU

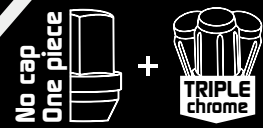

OEM Wheel Seat Application

OEM NUT

53025

Description: Close end 60° cone seat
Quantity: 30/box
Finish: Chrome
Thread: M12 x 1.25mm
Hex: 19mm
Overall length: 25.4mm
Seat diameter: 20.8mm



Aftermarket Wheel Seat Application

OPEN END CONE SEAT

1306

Description: Open end 60° cone seat
Quantity: 100/box
Finish: Chrome
Thread: M12 x 1.25mm
Hex: 19mm
Overall length: 16.1mm



1307

Description: Open end 60° cone seat
Quantity: 100/box
Finish: Chrome
Thread: M12 x 1.5mm
Hex: 19mm
Overall length: 16.1mm



OPEN END BULGE SEAT

1306-1S

Description: Open end bulge seat
Quantity: 100/box
Finish: Chrome
Thread: M12 x 1.25mm
Hex: 19mm
Overall length: 21.4mm



1307-1S

Description: Open end bulge seat
Quantity: 100/box
Finish: Chrome
Thread: M12 x 1.5mm
Hex: 19mm
Overall length: 21.4mm



CLOSE END CONE SEAT

1006

Description: Close end 60° cone seat
Quantity: 50/box
Finish: Chrome
Thread: M12 x 1.25mm
Hex: 21mm
Overall length: 35.3mm



1007

Description: Close end 60° cone seat
Quantity: 50/box
Finish: Chrome
Thread: M12 x 1.5mm
Hex: 21mm
Overall length: 35.3mm



CLOSE END BULGE SEAT

19075

Description: Close end bulge seat
Quantity: 50/box
Finish: Chrome
Thread: M12 x 1.5mm
Hex: 19mm
Overall length: 34.7mm
Seat diameter: 22mm



1707BK

Description: Close end bulge seat
Quantity: 50/box
Finish: Black Coat
Thread: M12 x 1.5mm
Hex: 19mm
Overall length: 34.5mm
Seat diameter: 22mm



19065

Description: Close end bulge seat
Quantity: 50/box
Finish: Chrome
Thread: M12 x 1.25mm
Hex: 19mm
Overall length: 35.6mm
Seat diameter: 22mm



Aftermarket Wheel Seat Application

OPEN END BULGE SEAT 6 SPLINE

3807-1C

Description: Open end bulge seat
Quantity: 100
Finish: Chrome
Thread: M12 x 1.5mm
Hex: 6 SPLINE
Overall length: 21mm
Seat diameter: 20.2mm
Operating key: 3800/3800s



3806-1C

Description: Open end bulge seat
Quantity: 100
Finish: Chrome
Thread: M12 x 1.25mm
Hex: 6 SPLINE
Overall length: 21mm
Seat diameter: 20.2mm
Operating key: 3800/3800s



CLOSE END BULGE SEAT 6 SPLINE

3806-C

Description: Close end bulge seat
Quantity: 80/box
Finish: Chrome
Thread: M12 x 1.25mm
Hex: 6 SPLINE
Overall length: 33.2mm
Seat diameter: 20.2mm
Operating key: 3800/3800s



3806-BK

Description: Close end bulge seat
Quantity: 80/box
Finish: Black coat
Thread: M12 x 1.25mm
Hex: 6 SPLINE
Overall length: 33.2mm
Seat diameter: 21mm
Operating key: 3800/3800s



3807-C

Description: Close end bulge seat
Quantity: 80/box
Finish: Chrome
Thread: M12 x 1.5mm
Hex: 6 SPLINE
Overall length: 33.2mm
Seat diameter: 20.2mm
Operating key: 3800/3800s



3807-BK

Description: Close end bulge seat
Quantity: 80/box
Finish: Black coat
Thread: M12 x 1.5mm
Hex: 6 SPLINE
Overall length: 33.2mm
Seat diameter: 21mm
Operating key: 3800/3800s



TUNER NUT

2806

Description: Inverted hex tuner nut
Quantity: 50/box
Finish: Chrome
Thread: M12 x 1.25mm
Hex: 12mm
Overall length: 32.6mm
Seat diameter: 20mm
Operating key: 2800



2807

Description: Inverted hex tuner nut
Quantity: 50/box
Finish: Chrome
Thread: M12 x 1.5mm
Hex: 12mm
Overall length: 32.6mm
Seat diameter: 20mm
Operating key: 2800



2807 BK

Description: Inverted hex tuner nut
Quantity: 50/box
Finish: Black coat
Thread: M12 x 1.5mm
Hex: 12mm
Overall length: 32.6mm
Seat diameter: 20mm
Operating key: 2800



DUAL HEX 6 SPLINE KEY

3800S

Description: 6 splines
Quantity: 30/box
Finish: Chrome
Hex: 17mm/19mm
Overall length: 73.1mm
Seat diameter: 20.4mm



3800

Description: 6 splines
Quantity: 20/box
Finish: Chrome/Black
Hex: 19mm/21mm
Overall length: 90mm
Seat diameter: 20.4mm



DUAL HEX TUNER KEY

2800

Quantity: 30/box
Finish: Chrome
Hex: 19mm/21mm
Key Hex: 12mm
Overall length: 57.9mm



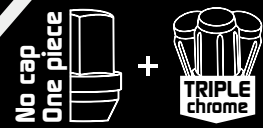

DEM NUTS

5330

Description: Close end bulge seat
Quantity: 30/box
Finish: Chrome
Thread: M14 x 1.5mm
Hex: 22mm
Overall length: 38.3mm
Seat diameter: 25mm



5330BK

Description: Close end bulge seat
Quantity: 30/box
Finish: Black coat
Thread: M14 x 1.5mm
Hex: 22mm
Overall length: 38.3mm
Seat diameter: 25mm

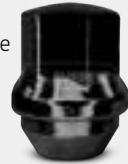

I312

Description: Open end bulge seat
Quantity: 70/box
Finish: Chrome
Thread: M14 x 1.5mm
Hex: 22mm
Overall length: 21.4mm



DUPLEX ACORN

540 I

Description: Close end Duplex Acorn
Quantity: 30/box
Finish: Chrome
Thread: M14 x 1.5mm
Hex: 22mm
Overall length: 48.2mm
Seat diameter: 25.5mm



540 I BK

Description: Close end Duplex Acorn
Quantity: 30/box
Finish: Black coat
Thread: M14 x 1.5mm
Hex: 22mm
Overall length: 48.2mm
Seat diameter: 25.5mm



OPEN END BULGE SEAT 7 SPLINE

3809-1DC

Description: Open end bulge seat
Quantity: 80/box
Finish: Chrome
Thread: M14 x 1.5mm
Hex: 7 SPLINE
Overall length: 25.4mm
Seat diameter: 23.3mm
Operating key: 3800L



CLOSE END BULGE SEAT 7 SPLINE

3809-DC

Description: Close end bulge seat
Quantity: 80/box
Finish: Chrome
Thread: M14 x 1.5mm
Hex: 7 SPLINE
Overall length: 43.1mm
Seat diameter: 19.4mm
Operating key: 3800L



3809-DBK

Description: Close end bulge seat
Quantity: 80/box
Finish: Black Coat
Thread: M14 x 1.5mm
Hex: 7 SPLINE
Overall length: 43.1mm
Seat diameter: 19.4mm
Operating key: 3800L



DUAL HEX SPLINE KEY

3800L

Description: 7 splines
Quantity: 20/box
Finish: Chrome/Black
Hex: 21mm/22mm
Overall length: 82mm
Seat diameter: 23mm



DEM NUTS

I33

Description: Close end 60° cone seat
Quantity: 50/box
Finish: Chrome
Thread: M12 x 1.5mm
Hex: 21mm
Overall length: 30mm



5307

Description: Close end shank seat with washer
Quantity: 40/box
Finish: Chrome
Thread: M12 x 1.5mm
Hex: 21mm
Overall length: 37mm
Seat diameter: 18.3mm
Washer diameter: 30mm



5307BK

Description: Close end shank seat with washer
Quantity: 40/box
Finish: Black coat
Thread: M12 x 1.5mm
Hex: 21mm
Overall length: 37mm
Seat diameter: 18.3mm
Washer diameter: 30mm



5307XL

Description: Close end shank seat with washer
Quantity: 30/box
Finish: Chrome
Thread: M12 x 1.5mm
Hex: 21mm
Overall length: 46mm
Seat diameter: 18.3mm
Washer diameter: 30mm

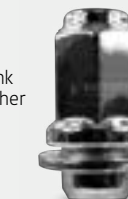

5309

Description: Close end shank seat with washer
Quantity: 25/box
Finish: Chrome
Thread: M14 x 1.5mm
Hex: 22mm
Overall length: 48.4mm
Seat diameter: 20.8mm
Washer diameter: 34mm



5302S

Description: Close end 60° cone seat
Quantity: 30/box
Finish: Chrome
Thread: M12 x 1.25mm
Hex: 19mm
Overall length: 25.4mm
Seat diameter: 20.8mm



OPEN END CONE SEAT

I327

Description: Open end 60° cone seat
Quantity: 100/box
Finish: Chrome
Thread: M12 x 1.5mm
Hex: 21mm
Overall length: 16mm



I306

Description: Open end 60° cone seat
Quantity: 100/box
Finish: Chrome
Thread: M12 x 1.25mm
Hex: 19mm
Overall length: 16.1mm



CLOSE END CONE SEAT

I006

Description: Close end 60° cone seat
Quantity: 50/box
Finish: Chrome
Thread: M12 x 1.25mm
Hex: 21mm
Overall length: 35.3mm



I007

Description: Close end 60° cone seat
Quantity: 50/box
Finish: Chrome
Thread: M12 x 1.5mm
Hex: 21mm
Overall length: 35.3mm



OPEN END BULGE SEAT

I307-1S

Description: Open end bulge seat
Quantity: 100/box
Finish: Chrome
Thread: M12 x 1.5mm
Hex: 19mm
Overall length: 21.4mm



I312

Description: Open end bulge seat
Quantity: 70/box
Finish: Chrome
Thread: M14 x 1.5mm
Hex: 22mm
Overall length: 21.4mm



I306-1S

Description: Open end bulge seat
Quantity: 100/box
Finish: Chrome
Thread: M12 x 1.25mm
Hex: 19mm
Overall length: 21.4mm



TOYOTA

TOYOTA

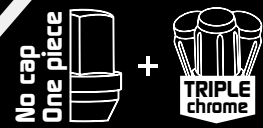

CLOSE END BULGE SEAT

1907S

Description: Close end bulge seat
Quantity: 50/box
Finish: Chrome
Thread: M12 x 1.5mm
Hex: 19mm
Overall length: 34.7mm
Seat diameter: 22mm



1707BK

Description: Close end bulge seat
Quantity: 50/box
Finish: Black Coat
Thread: M12 x 1.5mm
Hex: 19mm
Overall length: 34.5mm
Seat diameter: 22mm



1907SL

Description: Close end bulge seat
Quantity: 40/box
Finish: Chrome
Thread: M12 x 1.5mm
Hex: 19mm
Overall length: 50mm
Seat diameter: 23mm



1909L

Description: Close end bulge seat
Quantity: 40/box
Finish: Chrome
Thread: M14 x 1.5mm
Hex: 21mm
Overall length: 45mm
Seat diameter: 24mm



1906S

Description: Close end bulge seat
Quantity: 50/box
Finish: Chrome
Thread: M12 x 1.25mm
Hex: 19mm
Overall length: 35.6mm
Seat diameter: 22mm



DUPLEX ACORN

540 I

Description: Close end Duplex Acorn
Quantity: 30/box
Finish: Chrome
Thread: M14 x 1.5mm
Hex: 22mm
Overall length: 48.2mm
Seat diameter: 25.5mm



540 I BK

Description: Close end Duplex Acorn
Quantity: 30/box
Finish: Black coat
Thread: M14 x 1.5mm
Hex: 22mm
Overall length: 48.2mm
Seat diameter: 25.5mm



SHORT SHANK DUPLEX ACORN

3009

Description: Close end Duplex Acorn
Quantity: 30/box
Finish: Chrome
Thread: M14 x 1.5mm
Hex: 22mm
Overall length: 46.6mm
Seat diameter: 21.5mm



OPEN END BULGE SEAT 7 SPLINE

3809-1 DC

Description: Open end bulge seat
Quantity: 80/box
Finish: Chrome
Thread: M14 x 1.5mm
Hex: 7 SPLINE
Overall length: 25.4mm
Seat diameter: 23.3mm
Operating key: 3800L



CLOSE END BULGE SEAT 7 SPLINE

3809-DC

Description: Close end bulge seat
Quantity: 80/box
Finish: Chrome
Thread: M14 x 1.5mm
Hex: 7 SPLINE
Overall length: 43.1mm
Seat diameter: 19.4mm
Operating key: 3800L



3809-DBK

Description: Close end bulge seat
Quantity: 80/box
Finish: Black Coat
Thread: M14 x 1.5mm
Hex: 7 SPLINE
Overall length: 43.1mm
Seat diameter: 19.4mm
Operating key: 3800L



CLOSE END BULGE SEAT 6 SPLINE

3807-C

Description: Close end bulge seat
Quantity: 80/box
Finish: Chrome
Thread: M12 x 1.5mm
Hex: 6 SPLINE
Overall length: 33.2mm
Seat diameter: 20.2mm
Operating key: 3800/3800s



3807-BK

Description: Close end bulge seat
Quantity: 80/box
Finish: Black coat
Thread: M12 x 1.5mm
Hex: 6 SPLINE
Overall length: 33.2mm
Seat diameter: 21mm
Operating key: 3800/3800s



3806-C

Description: Close end bulge seat
Quantity: 80/box
Finish: Chrome
Thread: M12 x 1.25mm
Hex: 6 SPLINE
Overall length: 33.2mm
Seat diameter: 20.2mm
Operating key: 3800/3800s



3806-BK

Description: Close end bulge seat
Quantity: 80/box
Finish: Black coat
Thread: M12 x 1.25mm
Hex: 6 SPLINE
Overall length: 33.2mm
Seat diameter: 21mm
Operating key: 3800/3800s



OPEN END BULGE SEAT 6 SPLINE

3807-1 C

Description: Open end bulge seat
Quantity: 100
Finish: Chrome
Thread: M12 x 1.5mm
Hex: 6 SPLINE
Overall length: 21mm
Seat diameter: 20.2mm
Operating key: 3800/3800s



3806-1 C

Description: Open end bulge seat
Quantity: 100
Finish: Chrome
Thread: M12 x 1.25mm
Hex: 6 SPLINE
Overall length: 21mm
Seat diameter: 20.2mm
Operating key: 3800/3800s



DUAL HEX TUNER KEY

2800

Quantity: 30/box
Finish: Chrome
Hex: 19mm/21mm
Key Hex: 12mm
Overall length: 57.9mm



2800L

Quantity: 30/box
Finish: Chrome
Hex: 19mm/21mm
Key Hex: 14.7mm
Overall length: 63.5mm



TUNER NUT

2806

Description: Inverted hex tuner nut
Quantity: 50/box
Finish: Chrome
Thread: M12 x 1.25mm
Hex: 12mm
Overall length: 32.6mm
Seat diameter: 20mm
Operating key: 2800



2807

Description: Inverted hex tuner nut
Quantity: 50/box
Finish: Chrome
Thread: M12 x 1.5mm
Hex: 12mm
Overall length: 32.6mm
Seat diameter: 20mm
Operating key: 2800



2807 BK

Description: Inverted hex tuner nut
Quantity: 25/box
Finish: Black coat
Thread: M12 x 1.5mm
Hex: 12mm
Overall length: 32.6mm
Seat diameter: 20mm
Operating key: 2800



2807 L

Description: Inverted hex tuner nut
Quantity: 25/box
Finish: Chrome
Thread: M14 x 1.5mm
Hex: 15mm
Overall length: 45.4mm
Seat diameter: 20mm
Operating key: 2800L



DUAL HEX SPLINE KEY

3800S

Description: 6 splines
Quantity: 30/box
Finish: Chrome
Hex: 17mm/19mm
Overall length: 73.1mm
Seat diameter: 20.4mm



3800

Description: 6 splines
Quantity: 20/box
Finish: Chrome/Black
Hex: 19mm/21mm
Overall length: 90mm
Seat diameter: 20.4mm



3800L

Description: 7 splines
Quantity: 20/box
Finish: Chrome/Black
Hex: 21mm/22mm
Overall length: 82mm
Seat diameter: 23mm



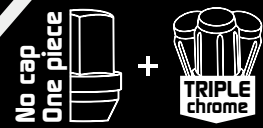

OEM Wheel Seat Application

OEM BOLT

18095 I

Description:
R13 Ball seat



Quantity: 50/box
Finish: Chrome
Thread: M14 x 1.5mm
Hex: 17mm
Overall length: 50mm
Thread length: 25mm
Seat diameter: 23mm

18095 I BK

Description:
R13 Ball seat



Quantity: 50/box
Finish: Black coat
Thread: M14 x 1.5mm
Hex: 17mm
Overall length: 50mm
Thread length: 25mm
Seat diameter: 23mm

1809Q

Description:
Variable ball seat R14



Quantity: 25/box
Finish: Dacromet
Thread: M14 x 1.5mm
Hex: 17mm
Overall length: 61mm
Thread length: 22mm
Seat diameter: 23.5mm

OEM SPLINED BOLT

18095 I PC

Description:
R13 Ball seat



Quantity: 50/box
Finish: Chrome
Thread: M14 x 1.5mm
Hex: 6 spline
Overall length: 50mm
Thread length: 25mm
Seat diameter: 23mm
Operating key: 3800/3800s

Aftermarket Wheel Seat Application

OEM SIZE BOLTS

18205

Description:
60° Cone seat



Quantity: 50/box
Finish: Chrome
Thread: M14 x 1.5mm
Hex: 17mm
Overall length: 50.5mm
Thread length: 24mm
Seat diameter: 22mm

18205BK

Description:
60° Cone seat



Quantity: 50/box
Finish: Black Coat
Thread: M14 x 1.5mm
Hex: 17mm
Overall length: 50.5mm
Thread length: 24mm
Seat diameter: 22mm

18095 I PBK

Description:
R13 Ball seat



Quantity: 50/box
Finish: Black coat
Thread: M14 x 1.5mm
Hex: 6 spline
Overall length: 50mm
Thread length: 25mm
Seat diameter: 23mm
Operating key: 3800/3800s

OEM SIZE SPLINE BOLT 6 SPLINE

18205SPC

Description:
60° Cone seat



Quantity: 50/box
Finish: Chrome
Thread: M14 x 1.5mm
Hex: 6 Spline
Overall length: 54.5mm
Thread length: 24mm
Seat diameter: 20.2mm
Operating key: 3800/3800s

18205SPBK

Description:
60° Cone seat



Quantity: 50/box
Finish: Black coat
Thread: M14 x 1.5mm
Hex: 6 Spline
Overall length: 54.5mm
Thread length: 24mm
Seat diameter: 20.2mm
Operating key: 3800/3800s

DUAL HEX SPLINE KEY

3800S

Description:
6 splines



Quantity: 30/box
Finish: Chrome
Hex: 17mm/19mm
Overall length: 73.1mm
Seat diameter: 20.4mm

3800

Description:
6 splines



Quantity: 20/box
Finish: Chrome/Black
Hex: 19mm/21mm
Overall length: 90mm
Seat diameter: 20.4mm

OEM BOLT

1820V

Description:
60° Cone seat



Quantity: 35/box
Finish: Chrome
Thread: M14 x 1.5mm
Hex: 19mm
Overall length: 61mm
Thread length: 26mm
Seat diameter: 25.2mm

OEM SIZE SPLINE BOLT 6 SPLINE

18205SPC

Description:
60° Cone seat



Quantity: 50/box
Finish: Chrome
Thread: M14 x 1.5mm
Hex: 6 Spline
Overall length: 54.5mm
Thread length: 24mm
Seat diameter: 20.2mm
Operating key: 3800/3800s

18205SPBK

Description:
60° Cone seat



Quantity: 50/box
Finish: Black coat
Thread: M14 x 1.5mm
Hex: 6 Spline
Overall length: 54.5mm
Thread length: 24mm
Seat diameter: 20.2mm
Operating key: 3800/3800s

OPEN END CONE SEAT

1307

Description:
Open end 60° cone seat



Quantity: 100/box
Finish: Chrome
Thread: M12 x 1.5mm
Hex: 19mm
Overall length: 16.1mm

OPEN END BULGE SEAT

1307-1S

Description:
Open end bulge seat



Quantity: 100/box
Finish: Chrome
Thread: M12 x 1.5mm
Hex: 19mm
Overall length: 21.4mm

CLOSE END CONE SEAT

1007

Description:
Close end 60° cone seat



Quantity: 50/box
Finish: Chrome
Thread: M12 x 1.5mm
Hex: 21mm
Overall length: 35.3mm

CLOSE END BULGE SEAT

1907S

Description:
Close end bulge seat



Quantity: 50/box
Finish: Chrome
Thread: M12 x 1.5mm
Hex: 19mm
Overall length: 34.7mm
Seat diameter: 22mm

1707BK

Description:
Close end bulge seat



Quantity: 50/box
Finish: Black Coat
Thread: M12 x 1.5mm
Hex: 19mm
Overall length: 34.5mm
Seat diameter: 22mm

OPEN END BULGE SEAT 6 SPLINE

3807-1C

Description:
Open end bulge seat



Quantity: 100
Finish: Chrome
Thread: M12 x 1.5mm
Hex: 21mm
Overall length: 21mm
Seat diameter: 20.2mm
Operating key: 3800/3800s

CLOSE END BULGE SEAT 6 SPLINE

3807-C

Description:
Close end bulge seat



Quantity: 80/box
Finish: Chrome
Thread: M12 x 1.5mm
Hex: 6 SPLINE
Overall length: 33.2mm
Seat diameter: 20.2mm
Operating key: 3800/3800s

3807-BK

Description:
Close end bulge seat



Quantity: 80/box
Finish: Black coat
Thread: M12 x 1.5mm
Hex: 6 SPLINE
Overall length: 33.2mm
Seat diameter: 21mm
Operating key: 3800/3800s

DUAL HEX TUNER KEY

2800



Quantity: 30/box
Finish: Chrome
Hex: 19mm/21mm
Key Hex: 12mm
Overall length: 57.9mm

TUNER NUT

2807

Description:
Inverted hex tuner nut



Quantity: 50/box
Finish: Chrome
Thread: M12 x 1.5mm
Hex: 12mm
Overall length: 32.6mm
Seat diameter: 20mm
Operating key: 2800

2807 BK

Description:
Inverted hex tuner nut



Quantity: 50/box
Finish: Black coat
Thread: M12 x 1.5mm
Hex: 12mm
Overall length: 32.6mm
Seat diameter: 20mm
Operating key: 2800

DUAL HEX 6 SPLINE KEY

3800S

Description:
6 splines



Quantity: 30/box
Finish: Chrome
Hex: 17mm/19mm
Overall length: 73.1mm
Seat diameter: 20.4mm

3800

Description:
6 splines



Quantity: 20/box
Finish: Chrome/Black
Hex: 19mm/21mm
Overall length: 90mm
Seat diameter: 20.4mm

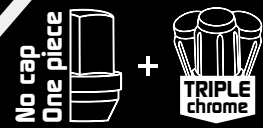

Lock Nuts

CLOSE END



- | | |
|--------------------------------------|--------------------------------------|
| AC-001
Thread: 7/16" | AC-007
Thread: 12 x 1.50mm |
| AC-003
Thread: 1/2" | AC-009
Thread: 14 x 1.50mm |
| AC-005
Thread: 12 x 1.25mm | |

OPEN END



- | | |
|--------------------------------------|--------------------------------------|
| OE-001
Thread: 7/16" | OE-007
Thread: 12 x 1.50mm |
| OE-003
Thread: 1/2" | OE-009
Thread: 14 x 1.50mm |
| OE-005
Thread: 12 x 1.25mm | |

UNIVERSAL



- AC-007-I**
Thread: 12 x 1.50mm

HONDA OEM



- AC-007HR**
Thread: 12 x 1.50mm

CONE SEAT



- | | |
|--|--|
| LB002-05
Thread: 12 x 1.25mm
Length: 26mm | LB002-09
Thread: 14 x 1.50mm
Length: 26mm |
| LB002-07
Thread: 12 x 1.50mm
Length: 26mm | |

BALL SEAT



- | | |
|--|--|
| LB003-05
Thread: 12 x 1.25mm
Length: 26mm | LB003-09
Thread: 14 x 1.50mm
Length: 26mm |
| LB003-07
Thread: 12 x 1.50mm
Length: 26mm | |

INSTALLATION KITS

CHROME KITS

- | | |
|--|---|
| AC-3804
20 spline nuts,
4 chrome valves and 1 key
Thread: 1/2" | AC-3806
20 spline nuts,
4 chrome valves and 1 key
Thread: 12mm x 1.25 |
| AC-3807
20 spline nuts,
4 chrome valves and 1 key
Thread: 12mm x 1.5 | AC-3809
20 spline nuts,
4 chrome valves and 1 key
Thread: 14mm x 1.5 |



BLACK KITS

- | | |
|--|---|
| AC-3804BK
20 spline nuts,
4 chrome valves and 1 key
Thread: 1/2" | AC-3806BK
20 spline nuts,
4 chrome valves and 1 key
Thread: 12mm x 1.25 |
| AC-3807BK
20 spline nuts,
4 chrome valves and 1 key
Thread: 12mm x 1.5 | AC-3809BK
20 spline nuts,
4 chrome valves and 1 key
Thread: 14mm x 1.5 |



LONG CHROME KITS

- | | |
|---|---|
| AC-3804L
20 spline nuts,
4 chrome valves and 1 key
Thread: 1/2" | AC-3807L
20 spline nuts,
4 chrome valves and 1 key
Thread: 12mm x 1.5 |
| AC-3809L
20 spline nuts,
4 chrome valves and 1 key
Thread: 14mm x 1.5 | AC-3810L
20 spline nuts,
4 chrome valves and 1 key
Thread: 9/16" |
| AC-3850L
20 spline nuts,
4 chrome valves and 1 key
Thread: 14mm x 2.0 | |



LONG BLACK KITS

- | | |
|---|---|
| AC-3804L
20 spline nuts,
4 chrome valves and 1 key
Thread: 1/2" | AC-3807LBK
20 spline nuts,
4 chrome valves and 1 key
Thread: 12mm x 1.5 |
| AC-3809LBK
20 spline nuts,
4 chrome valves and 1 key
Thread: 14mm x 1.5 | AC-3810LBK
20 spline nuts,
4 chrome valves and 1 key
Thread: 9/16" |
| AC-3850LBK
20 spline nuts,
4 chrome valves and 1 key
Thread: 14mm x 2.0 | |

